



shaping your dreams

OSG ASIA LOGISTICS CENTRE

VOL. 4.0









**Empowered By
OSG Asia Logistics Centre**

■ Guide of (Tool Specification) Icons

1 Tool Materials

 Tungsten Carbide	 HSS with 3% Vanadium
 Powder Metallurgy HSS	 HSS
 HSS with 8% Cobalt	

2 Surface Treatment

 FX Coating	 TiN Coating
 TiAlN Coating	 CrN Coating
 V Coating	 Steam Oxide
 WDI Coating	 Gold Oxide
 HR Coating	 Blue Finish
 WXL Coating	 WXS Coating

3 Tolerance for diameter

 Tolerance	 Tolerance for milling diameter
---	--

4 Chamfer

 Chamfer length
--

5 Thread Depth & Hole Type

 Through Hole	 Blind Hole
--	--

6 Shank

 Tolerance for shank diameter	 Suitable for the shrink holder system
--	---

7 Helix Angle

 Display helix angle of flute for drills and taps
--

8 Corner Form

 Indicates that the end mill has a sharp corner edge

9 Tolerance of Ball-End Radius

 Identifies the tolerance of the radius for ball-end mills

Stock Item List

TAPS

pg 6 to 40

CARBIDE DRILLS

pg 44 to 55

CARBIDE END MILLS

pg 58 to 69

HSS END MILLS

pg 72 to 76

SOMTA TOOLS

pg 80 to 92

INFORMATION

- Stocks of OSG catalogue EDP No. Items are not included in this catalogue. Please refer to OSG Japan Catalogues (Drilling Threading Tools & Milling Tools).
- Tool specification is subject to change without prior notice . Depending on the situation, some products maybe sold out or get discontinued.

TAPS

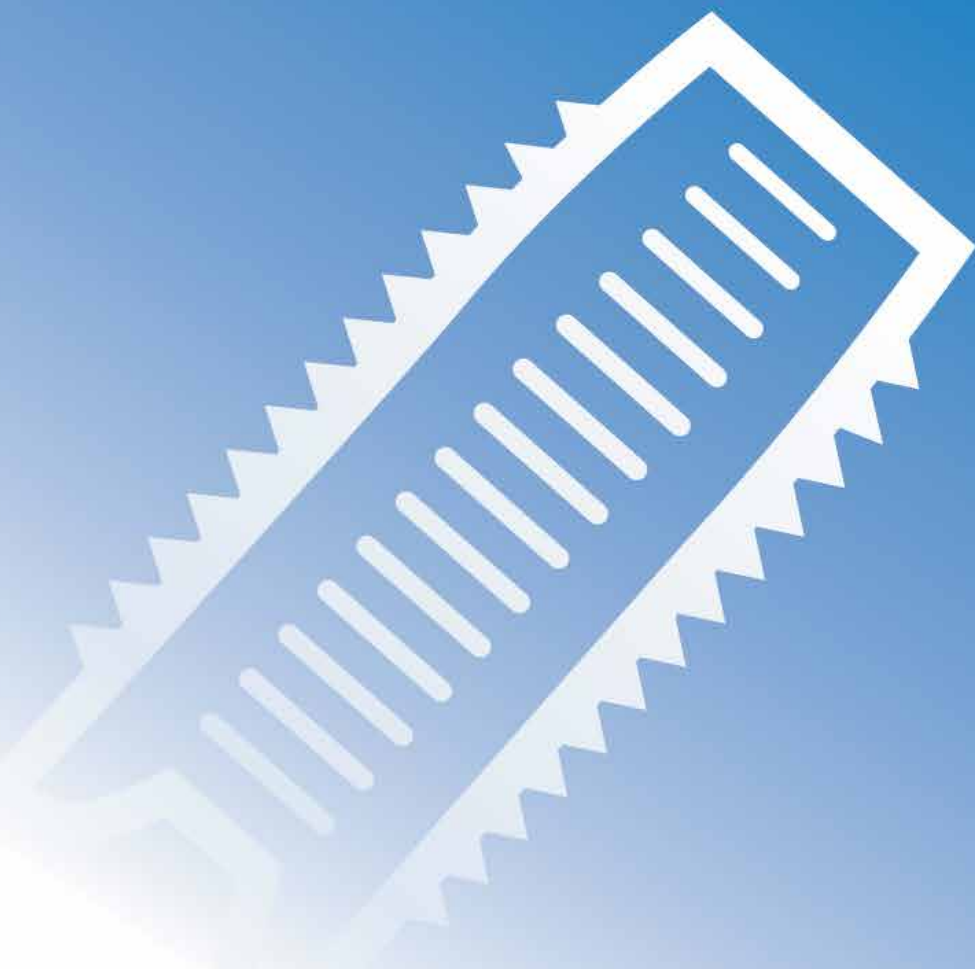

Page	Symbol	DIN type	Surface Treatment	Stocked Size	
6	A-POT	METRIC DIN 371	V	M3~M10	
		METRIC DIN 376	V	M12~M24	
		METRIC DIN 374	V	M6~M24	
7		UNC DIN 2184-1	V	4-40 UNC~ 1-8 UNC	
		UNF DIN 2184-1	V	6-40 UNF~ 1-8 UNF	
8		A-SFT	METRIC DIN 371	V	M3~M10
	METRIC DIN 376		V	M12~M24	
	METRIC DIN 374		V	M6~M24	
9	UNC DIN 2184-1		V	4-40 UNC~ 1-8 UNC	
	UNF DIN 2184-1		V	10-32 UNF~ 7/8-14 UNF	
10	METRIC DIN 2184		V	1/4-20~2-8	
	Rc DIN 5156		V	Rc 1/6~Rc 1	
11	A-SFT (FORM E)		METRIC DIN 371	V	M3~M10
			METRIC DIN 376	V	M3~M5
		METRIC DIN 374	V	M8~M12	
12	VA-POT	METRIC DIN 371	OX	M2~M10	
		METRIC FINE DIN 374	OX	M3~M24	
13		METRIC DIN 376	OX	M12~M36	
		METRIC DIN 371	OX	M2~M10	
14		METRIC DIN 376	OX	M12~M16	
		UNC DIN 2184-1	OX	4-40 UNC~3/8-16 UNC	
15		UNC DIN 2184-1	OX	7/16-14 UNC~1-8 UNC	
		UNF DIN 2184-1	OX	6-40 UNF~3/8-24 UNF	
		UNF DIN 2184-1	OX	7/16-20 UNF~1-12 UNF	
		UN(J)C DIN 2184-1	OX	4-40 UNJC~8-32 UNJC	
16		UNJ(F) DIN 2184-1	OX	10-32 UNJF~3/8-24 UNJF	
		UNJ(F) DIN 2184-1	OX	7/16-20 UNJF~1/2-20 UNJF	
	17	METRIC DIN 371	OX	M2~M10	
		METRIC FINE DIN 374	OX	M3~M24	
	18	METRIC DIN 376	OX	M12~M36	
		METRIC DIN 371	OX	M2~M10	
METRIC DIN 371		OX	M12~M16		
UNC DIN 2184-1		OX	4-40 UNC~3/8-16 UNC		
UNC DIN 2184-1		OX	7/16-14 UNC~1-8 UNC		
UNF DIN 2184-1		OX	6-40 UNF~3/8-24 UNF		
19	UNF DIN 2184-1	OX	7/16-20 UNF~1-12 UNF		
	UN(J)C DIN 2184-1	OX	4-40 UNJC~8-32 UNJC		
	UNJ(F) DIN 2184-1	OX	10-32 UNJF~3/8-24 UNJF		
	UNJ(F) DIN 2184-1	OX	7/16-20 UNJF~1/2-20 UNJF		
20	VA-SFT (FORM E)	G Thread DIN 5156	OX	G1/8-28~G1-11	
		METRIC DIN 371	OX	M3~M10	
21	POT	METRIC DIN 376	OX	M12~M16	
		METRIC DIN 371	-	M3~M10	
	SFT	METRIC DIN 376	-	M12~M24	
		METRIC DIN 371	-	M3~M10	
22	CC-SFT	METRIC DIN 376	-	M12~M24	
		METRIC DIN 371	CrN	M2~M10	
		METRIC DIN 376	CrN	M12~M24	
23		UN(J)C DIN 2184-1	CrN	8-32 UNJC~3/8-16 UNJC	
		UN(J)C DIN 2184-1	CrN	7/16-14 UNJC~1-8 UNJC	
CC-SFT-SPT		UNJ(F) DIN 2184-1	CrN	10-32 UNJF~3/8-24 UNJF	
	UNJ(F) DIN 2184-1	CrN	7/16-20 UNJF~1/2-20 UNJF		
		G Series DIN 5156	CrN	G1/8-28~G1/2-14	

TAPS CONTENTS

Page	Symbol	DIN type	Surface Treatment	Stocked Size		
24	CC-HL-SFT	UN(J)F DIN 2184-1	CrN	10-32UNJF~3/8-24 UNJF		
	WHR-NI-SFT	UNJ(F) DIN 2184-1	HR	10-32 UNJF~1/2-20UNJF		
25	AW-SFT	METRIC DIN 371	-	M5~M10		
		METRIC DIN 376	-	M12~M16		
		METRIC DIN 374	-	M10~M20		
26	V-AW-SFT	METRIC DIN 371	V	M5~M10		
		METRIC DIN 376	V	M12~M16		
		METRIC DIN 374	V	M10~M20		
27	V-TI-SFT	METRIC DIN 371	V	M3~M10		
		METRIC DIN 376	V	M12		
		UN(J)C DIN 2184-1	V	4-40 UNJC~8-32 UNJC		
		UNJ(F) DIN 2184-1	V	10-32 UNJF~3/8-24 UNJF		
28	VPO-LW-SFT	METRIC DIN 371	V	M6~M10		
		METRIC DIN 376	V	M12~M16		
		METRIC FINE DIN 374	V	M9~M16		
29	WXL-CPM-RFT	METRIC DIN 371	WXL	M6~M10		
		METRIC DIN 376	WXL	M11~M18		
		METRIC FINE DIN 374	WXL	M8~M18		
30	VXL-SFT	UNC /UN	OX	1-8 UNC~2-8 UN		
	HXL-SFT	UNC /UN	OX	1-8 UNC~2-8 UN		
31	V-XPM-HT	METRIC DIN 371	V	M3~M10		
		METRIC DIN 376	V	M12		
	VPO-MT	METRIC DIN 371	V	M6~M8		
		METRIC DIN 376	V	M14~M16		
32	TPT (NPT)	METRIC DIN 374	V	M10~M16		
		DIN 2181	-	NPT 1/16-27~NPT 1-11.5		
		METRIC DIN 371	V	M5~M10		
		METRIC DIN 376	V	M12~M24		
		METRIC FINE DIN 374	V	M10~M24		
		34	V-DC-MT	UNC DIN 2184-1	V	4-40 UNC~3/8-16 UNC
				UNC DIN 2184-1	V	7/16-14 UNC~1-8 UNC
UNF DIN 2184-1	V			6-40 UNF~3/8-24 UNF		
35	OIL-V-DC-MT	UNF DIN 2184-1	V	7/16-20 UNF~1-12 UNF		
		METRIC DIN 371	V	M5~M10		
		METRIC DIN 376	V	M12~M18		
36	V-DC-MT (FORM E)	METRIC FINE DIN 374	V	M10~M24		
		METRIC DIN 371	V	M6~M10		
		METRIC DIN 376	V	M12		
37	S-XPF	METRIC FINE DIN 374	V	M8~M12		
		METRIC DIN 2174	V	M6~M10		
		METRIC DIN 2174	V	M12~M16		
38	OIL-S-XPF	METRIC DIN 2174	V	M8~M20		
		METRIC DIN 2174	V	M6~M10		
		METRIC DIN 2174	V	M8~M18		
39	V-NRT-B	METRIC DIN 2174	V	M12~M18		
		METRIC DIN 2174	V	M1~M5		
	R-XPF	JIS FORM	V	M3~M6		
40	HT SKS 	METRIC DIN 2174	V	M3~M6		
		METRIC JIS 3	-	M1~M10		

TAPS

CONTENTS



DIN HIGH PERFORMANCE TAP



Applicable for various types of work material group and wide range of cutting condition. Consistent performance is available due to the newly developed flute form which improves chip disposal.

A-POT

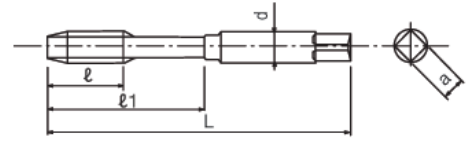

METRIC DIN 371

Unit:mm

EDP NO.	Thread Size	TAP Limit	L	ℓ	ℓ1	d	a	Z	List Price (USD)
48145138	M3 x 0.5	6HX	56	11	18	3.5	2.7	3	26.65
48145144	M4 x 0.7	6HX	63	13	21	4.5	3.4	3	27.36
48145149	M5 x 0.8	6HX	70	16	25	6	4.9	3	28.17
48145155	M6 x 1	6HX	80	19	30	6	4.9	3	28.44
48145161	M8 x 1.25	6HX	90	22	35	8	6.2	3	34.11
48145169	M10 x 1.5	6HX	100	24	39	10	8	3	41.58

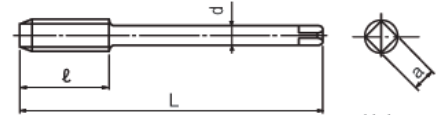

Unit:mm

METRIC DIN 376

EDP NO.	Thread Size	TAP Limit	L	ℓ	ℓ1	d	a	Z	List Price (USD)
48145179	M12 x 1.75	6HX	110	28	-	9	7	3	52.38
48145191	M14 x 2	6HX	110	30	-	11	9	3	62.46
48145202	M16 x 2	6HX	110	32	-	12	9	3	73.39
48145214	M18 x 2.5	6HX	125	34	-	14	11	3	99.23
48145228	M20 x 2.5	6HX	140	34	-	16	12	3	117.54
48145238	M22 x 2.5	6HX	140	34	-	18	14.5	3	138.70
48145247	M24 x 3	6HX	160	38	-	18	14.5	3	151.25



Unit:mm

METRIC DIN 374

EDP NO.	Thread Size	TAP Limit	L	ℓ	ℓ1	d	a	Z	List Price (USD)
48145156	M6 x 0.75	6HX	80	14	-	4.5	3.4	3	31.27
48145162	M8 x 1	6HX	90	22	-	6	4.9	3	37.48
48145171	M10 x 1	6HX	90	20	-	7	5.5	3	54.09
48145170	M10 x 1.25	6HX	100	24	-	7	5.5	3	45.77
48145182	M12 x 1	6HX	100	22	-	9	7	3	68.09
48145181	M12 x 1.25	6HX	100	22	-	9	7	3	62.86
48145180	M12 x 1.5	6HX	100	22	-	9	7	3	57.60
48145192	M14 x 1.5	6HX	100	22	-	11	9	4	68.72
48145203	M16 x 1.5	6HX	100	22	-	12	9	4	80.73
48145216	M18 x 1.5	6HX	110	25	-	14	11	4	109.13
48145230	M20 x 1.5	6HX	125	25	-	16	12	4	129.28
48145240	M22 x 1.5	6HX	125	25	-	18	14.5	4	134.46
48145250	M24 x 1.5	6HX	140	28	-	18	14.5	4	166.41

Work Material	Carbon Steels				Alloy Steels				Hardened Steels				Stainless Steels	Tool Steels	Cast Steels	Cast Iron	Ductile Cast Iron	Copper	Brass	Brass Casting	Bronze	Aluminum Rolled	Aluminum Alloy Casting	Magnesium Alloy Casting	Zinc Alloy Casting	Titanium Alloy	Nickel Alloy	Thermo Setting Plastic	Thermo Plastic
	Low Carbon Steels	Medium Carbon Steels	High Carbon Steels	Alloy Steels	25-35 HRC	35-45 HRC	45-50 HRC	50-60 HRC	SUS	SKD	SC	FC	FCD	Cu	Bs	BsC	PB	AL	AC,ADC	MC	ZDC								
A-POT	○	○	○	○	○	○			○	○	○		○	○			○	○	○	○	○	○	○	○	○				

Applicable for various types of work material group and wide range of cutting condition. Consistent performance is available due to the newly developed flute form which improves chip disposal.



DIN HIGH PERFORMANCE TAP

A-POT

HSS TAPS DIN

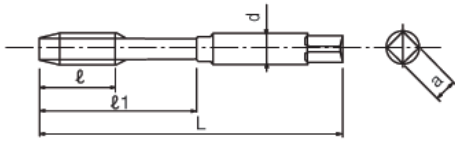

UNC DIN 2184-1

Unit:mm

EDP NO.	Thread Size	TAP Limit	L	ℓ	ℓ1	d	a	Z	List Price (USD)
48145457	4-40 UNC	2BX	56	11	18	3.5	2.7	2	30.73
48145459	5-40 UNC	2BX	56	11	18	3.5	2.7	3	30.73
48145461	6-32 UNC	2BX	56	12	20	4	3	3	29.16
48145464	8-32 UNC	2BX	63	13	21	4.5	3.4	3	29.16
48145466	10-24 UNC	2BX	70	16	25	6	4.9	3	30.73
48145471	1/4-20 UNC	2BX	80	19	30	7	5.5	3	32.76
48145474	5/16-18 UNC	2BX	90	22	35	8	6.2	3	36.86
48145479	3/8-16 UNC	2BX	100	24	39	10	8	3	41.26

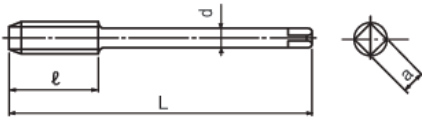

UNC DIN 2184-1

Unit:mm

EDP NO.	Thread Size	TAP Limit	L	ℓ	ℓ1	d	a	Z	List Price (USD)
48145484	7/16-14 UNC	2BX	100	24	-	8	6.2	3	50.17
48145489	1/2-13 UNC	2BX	110	28	-	9	7	3	54.95
48145494	9/16-12 UNC	2BX	110	30	-	11	9	3	61.43
48145501	5/8-11 UNC	2BX	110	32	-	12	9	3	67.55
48145515	3/4-10 UNC	2BX	125	34	-	14	11	3	91.31
48145526	7/8-9 UNC	2BX	140	34	-	18	14.5	3	110.75
48145538	1-8 UNC	2BX	160	38	-	18	14.5	3	144.94

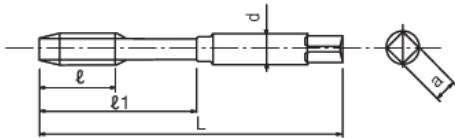

UNF DIN 2184-1

Unit:mm

EDP NO.	Thread Size	TAP Limit	L	ℓ	ℓ1	d	a	Z	List Price (USD)
48145462	6-40 UNF	2BX	56	12	20	4	3	3	40.69
48145467	10-32 UNF	2BX	70	16	25	6	4.9	3	41.40
48145472	1/4-28 UNF	2BX	80	19	30	7	5.5	3	45.01
48145476	5/16-24 UNF	2BX	90	22	35	8	6.2	3	48.11
48145481	3/8-24 UNF	2BX	90	20	35	10	8	3	52.06

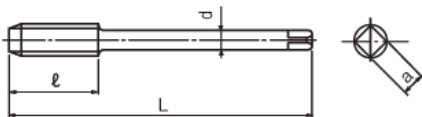

UNF DIN 2184-1

Unit:mm

EDP NO.	Thread Size	TAP Limit	L	ℓ	ℓ1	d	a	Z	List Price (USD)
48145486	7/16-20 UNF	2BX	100	24	-	8	6.2	3	65.66
48145491	1/2-20 UNF	2BX	100	22	-	9	7	3	62.29
48145496	9/16-18 UNF	2BX	100	22	-	11	9	3	73.66
48145504	5/8-18 UNF	2BX	100	22	-	12	9	3	85.19
48145517	3/4-16 UNF	2BX	110	25	-	14	11	3	109.57
48145528	7/8-14 UNF	2BX	125	25	-	18	14.5	3	138.6
48145539	1-12 UNF	2BX	140	28	-	18	14.5	3	183.82

Work Material	Carbon Steels				Alloy Steels				Hardened Steels				Stainless Steels	Tool Steels	Cast Steels	Cast Iron	Ductile Cast Iron	Copper	Brass	Brass Casting	Bronze	Aluminum Rolled	Aluminum Alloy Casting	Magnesium Alloy Casting	Zinc Alloy Casting	Titanium Alloy	Nickel Alloy	Thermo Setting Plastic	Thermo Plastic
	Low Carbon Steels	Medium Carbon Steels	High Carbon Steels	Alloy Steels	25-35 HRC	35-45 HRC	45-50 HRC	50-60 HRC	SUS	SKD	SC	FC	FCD	Cu	Bs	BsC	PB	AL	AC,ADC	MC	ZDC								
Abbreviation	C	C0.25%	C0.25%-0.45%	C	0.45%-																								
A-POT	○	○	○	○	○	○			○	○	○	○	○	○	○	○	○	○	○	○	○	○	○	○	○				

DIN HIGH PERFORMANCE TAP



Applicable for various types of work material group and wide range of cutting condition. Consistent performance is available due to the newly developed flute form which improves chip disposal.

A-SFT

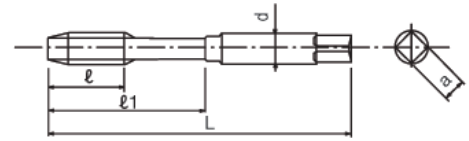

METRIC DIN 371

Unit:mm

EDP NO.	Thread Size	TAP Limit	L	ℓ	ℓ1	d	a	Z	List Price (USD)
48139138	M3 x 0.5	6HX	56	4	18	3.5	2.7	3	27.46
48139144	M4 x 0.7	6HX	63	5.6	21	4.5	3.4	3	28.22
48139149	M5 x 0.8	6HX	70	6.4	25	6	4.9	3	29.03
48139155	M6 x 1	6HX	80	8	30	6	4.9	3	29.35
48139161	M8 x 1.25	6HX	90	10	35	8	6.2	3	35.15
48139169	M10 x 1.5	6HX	100	12	39	10	8	3	42.88

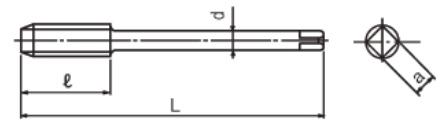

METRIC DIN 376

Unit:mm

EDP NO.	Thread Size	TAP Limit	L	ℓ	ℓ1	d	a	Z	List Price (USD)
48139179	M12 x 1.75	6HX	110	14	-	9	7	3	54.00
48139191	M14 x 2	6HX	110	16	-	11	9	3	64.40
48139202	M16 x 2	6HX	110	16	-	12	9	3	75.65
48139214	M18 x 2.5	6HX	125	25	-	14	11	4	102.28
48139228	M20 x 2.5	6HX	140	25	-	16	12	4	121.18
48139238	M22 x 2.5	6HX	140	25	-	18	14.5	4	142.97
48139247	M24 x 3	6HX	160	30	-	18	14.5	4	155.93

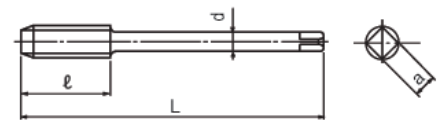

METRIC DIN 374

Unit:mm

EDP NO.	Thread Size	TAP Limit	L	ℓ	ℓ1	d	a	Z	List Price (USD)
48139156	M6 x 0.75	6HX	80	8	-	4.5	3.4	3	32.27
48139162	M8 x 1	6HX	90	10	-	6	4.9	3	38.66
48139171	M10 x 1	6HX	90	10	-	7	5.5	3	55.76
48139170	M10 x 1.25	6HX	100	12	-	7	5.5	3	47.17
48139182	M12 x 1	6HX	100	12	-	9	7	3	70.20
48139181	M12 x 1.25	6HX	100	12	-	9	7	3	64.80
48139180	M12 x 1.5	6HX	100	14	-	9	7	3	59.40
48139192	M14 x 1.5	6HX	100	16	-	11	9	3	70.83
48139203	M16 x 1.5	6HX	100	16	-	12	9	3	83.21
48139216	M18 x 1.5	6HX	110	16	-	14	11	4	112.51
48139230	M20 x 1.5	6HX	125	16	-	16	12	4	133.30
48139240	M22 x 1.5	6HX	125	16	-	18	14.5	4	138.60
48139250	M24 x 1.5	6HX	140	16	-	18	14.5	4	171.54

Work Material Abbreviation	Low Carbon Steels	Medium Carbon Steels	High Carbon Steels	Alloy Steels	Hardened Steels				Stainless Steels	Tool Steels	Cast Steels	Cast Iron	Ductile Cast Iron	Copper	Brass	Brass Casting	Bronze	Aluminum Rolled	Aluminum Alloy Casting	Magnesium Alloy Casting	Zinc Alloy Casting	Titanium Alloy	Nickel Alloy	Thermo Setting Plastic	Thermo Plastic
	C ~0.25%	C0.25% ~0.45%	C 0.45%~		SCM	25-35 HRC	35-45 HRC	45-50 HRC																	
A-SFT	○	○	○	○	○	○	○	○	○	○	○	○	○	○	○	○	○	○	○	○	○	○	○	○	

Applicable for various types of work material group and wide range of cutting condition. Consistent performance is available due to the newly developed flute form which improves chip disposal.



DIN HIGH PERFORMANCE TAP

A-SFT

HSS TAPS DIN

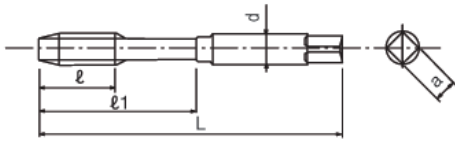

UNC DIN 2184-1

Unit:mm

EDP NO.	Thread Size	TAP Limit	L	ℓ	ℓ1	d	a	Z	List Price (USD)
48139457	4-40 UNC	2BX	56	5.1	18	3.5	2.7	2	37.40
48139461	6-32 UNC	2BX	56	6.4	20	4	3	2	35.37
48139464	8-32 UNC	2BX	63	6.4	21	4.5	3.4	2	35.32
48139466	10-24 UNC	2BX	70	8.5	25	6	4.9	2	37.40
48139471	1/4-20 UNC	2BX	80	10.2	30	7	5.5	2	41.40
48139474	5/16-18 UNC	2BX	90	11.3	35	8	6.2	3	43.25
48139479	3/8-16 UNC	2BX	100	12.7	39	10	8	3	48.01

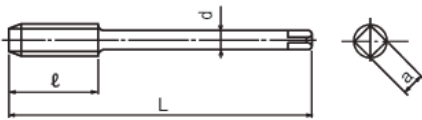

UNC DIN 2184-1

Unit:mm

EDP NO.	Thread Size	TAP Limit	L	ℓ	ℓ1	d	a	Z	List Price (USD)
48139484	7/16-14 UNC	2BX	100	14.5	-	8	6.2	3	63.05
48139489	1/2-13 UNC	2BX	110	15.6	-	9	7	3	65.61
48139501	5/8-11 UNC	2BX	110	18.5	-	12	9	3	87.57
48139515	3/4-10 UNC	2BX	125	25.4	-	14	11	4	108.59
48139526	7/8-9 UNC	2BX	140	28.2	-	18	14.5	4	138.06
48139538	1-8 UNC	2BX	160	31.8	-	18	14.5	4	182.88

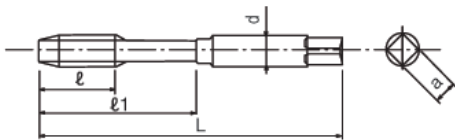

Unit:mm

UNF DIN 2184-1

EDP NO.	Thread Size	TAP Limit	L	ℓ	ℓ1	d	a	Z	List Price (USD)
48139467	10-32 UNF	2BX	70	8.5	25	6	4.9	2	51.84
48139472	1/4-28 UNF	2BX	80	10.2	30	7	5.5	2	58.64
48139476	5/16-24 UNF	2BX	90	11.3	35	8	6.2	3	61.65
48139481	3/8-24 UNF	2BX	90	12.7	35	10	8	3	62.91

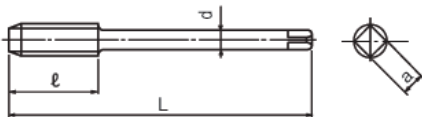

Unit:mm

UNF DIN 2184-1

EDP NO.	Thread Size	TAP Limit	L	ℓ	ℓ1	d	a	Z	List Price (USD)
48139486	7/16-20 UNF	2BX	100	14.5	-	8	6.2	3	67.96
48139491	1/2-20 UNF	2BX	100	15.6	-	9	7	3	67.10
48139496	9/16-18 UNF	2BX	100	16.9	-	11	9	3	78.35
48139504	5/8-18 UNF	2BX	100	18.5	-	12	9	3	89.59
48139517	3/4-16 UNF	2BX	110	25.4	-	14	11	4	115.61
48139528	7/8-14 UNF	2BX	125	28.2	-	18	14.5	4	141.97
48139539	1-12 UNF	2BX	140	31.8	-	18	14.5	4	197.78

Work Material Abbreviation	Work Material				Hardened Steels				Stainless Steels	Tool Steels	Cast Steels	Cast Iron	Ductile Cast Iron	Copper	Brass	Brass Casting	Bronze	Aluminum Rolled	Aluminum Alloy Casting	Magnesium Alloy Casting	Zinc Alloy Casting	Titanium Alloy	Nickel Alloy	Thermo Setting Plastic	Thermo Plastic
	Low Carbon Steels	Medium Carbon Steels	High Carbon Steels	Alloy Steels	25-35 HRC	35-45 HRC	45-50 HRC	50-60 HRC	SUS	SKD	SC	FC	FCD	Cu	Bs	BsC	PB	AL	AC,ADC	MC	ZDC				
A-SFT	○	○	○	○	○				○	○	○		○	○	○	○	○	○	○	○	○				

DIN HIGH PERFORMANCE TAP
(FOR OIL & GAS INDUSTRY)



A-SFT

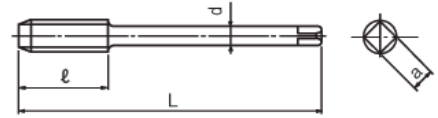

UNC DIN 2184-1

Unit:mm

EDP NO.	Thread Size	TAP Limit	L	ℓ	d	a	Z	List Price (USD)
T1403785	1/4 - 20 UNC	2B	80	10.2	4.5	3.4	2	41.31
T1403786	5/16 - 18 UNC	2B	90	11.3	6	4.9	3	43.20
T1403787	3/8 - 16 UNC	2B	100	12.7	7	5.5	3	47.88
T1403788	7/16 - 14 UNC	2B	100	14.5	8	6.2	3	62.87
T1403789	1/2 - 13 UNC	2B	110	15.6	9	7	3	65.43
T1403790	9/16 - 12 UNC	2B	110	16.9	11	9	3	78.75
T1403791	5/8 - 11 UNC	2B	110	18.5	12	9	3	87.30
T1403792	3/4 - 10 UNC	2B	125	25.4	14	11	4	108.36
T1403793	7/8 - 9 UNC	2B	140	28.2	18	14.5	4	151.20
T1404148	1 - 8 UNC	2B	160	31.8	18	14.5	4	182.39
T1403650	1 1/8 - 8 UNC	2B	180	38.1	22	18	4	330.75
T1403651	1 1/4 - 8 UNC	2B	180	38.1	22	18	4	400.10
T1403652	1 3/8 - 8 UNC	2B	200	38.1	28	22	4	448.11
T1403653	1 1/2 - 8 UNC	2B	200	38.1	28	22	4	576.18
T1403794	1 5/8 - 8 UNC	2B	200	38.1	32	24	4	880.20
T1403654	1 3/4 - 8 UNC	2B	200	38.1	36	29	4	1050.93
T1403795	1 7/8 - 8 UNC	2B	225	38.1	36	29	4	1232.82
T1403655	2 - 8 UNC	2B	225	38.1	40	32	4	1493.73

Work Material Abbreviation	Aluminum		Cast Iron	Low Carbon Steel	Med. Carbon Steel	High Carbon Steel	Alloy Steels	Die Steels	Titanium	High Nickel Alloy	Stainless Steels			Hardened Steels		
	6061 7075	Casting		1010 1018	1035 1045	1065	4140 4340	20 HRC	6Al4V (30HRC)	20 HRC	300	400	17-4PH	~35 HRC	35-45 HRC	45-50 HRC
A-SFT	○	○	○	○	○	○	○	○			○	○	○	○		

DIN HIGH PERFORMANCE TAP

A-SFT RC (ISO)

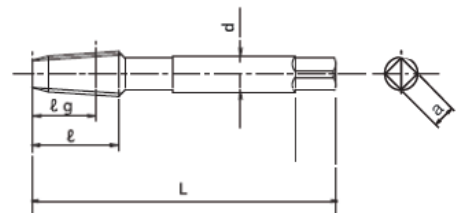
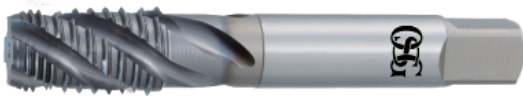

DIN 5156

Unit:mm

EDP NO.	Thread Size	TAP Limit	L	ℓg	ℓ	d	a	Z	List Price (USD)
48302374	Rc 1/6-28	-	90	10.1	14	6	4.9	3	98.69
48302384	Rc 1/8-28	-	90	10.1	15	7	5.5	3	79.02
48302394	Rc 1/4-19	-	100	15	19	11	9	3	117.09
48302404	Rc 3/8-19	-	110	15.4	21	12	9	4	183.24
48302414	Rc 1/2-14	-	125	20.5	26	16	12	4	278.24
48302434	Rc 3/4-14	-	140	21.8	28	20	16	4	464.63
48302454	Rc 1-11	-	160	26	33	25	23	4	884.61

Work Material Abbreviation	Low Carbon Steels	Medium Carbon Steels	High Carbon Steels	Alloy Steels	Hardened Steels				Stainless Steels	Tool Steels	Cast Steels	Cast Iron	Ductile Cast Iron	Copper	Brass	Brass Casting	Bronze	Aluminum Rolled	Aluminum Alloy Casting	Magnesium Alloy Casting	Zinc Alloy Casting	Titanium Alloy	Nickel Alloy	Thermo Setting Plastic	Thermo Plastic
	C -0.25%	CO.25% -0.45%	C 0.45%-	SCM	25-35 HRC	35-45 HRC	45-50 HRC	50-60 HRC	SUS	SKD	SC	FC	FCD	Cu	Bs	BsC	PB	AL	AC,ADC	MC	ZDC				
A-SFT	○	○	○	○	○	○	○	○	○	○	○	○	○	○	○	○	○	○	○	○	○	○	○	○	○

Applicable for various types of work material group and wide range of cutting condition. Consistent performance is available due to the newly developed flute form which improves chip disposal.



DIN HIGH PERFORMANCE TAP

A-SFT (FORM E)

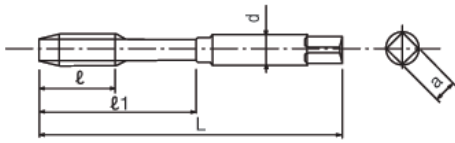

METRIC DIN 371

Unit:mm

EDP NO.	Thread Size	TAP Limit	L	ℓ	ℓ1	d	a	Z	List Price (USD)
48203138	M3x0.5	6HX	56	4	18	3.5	2.7	3	27.45
48203144	M4x0.7	6HX	63	5.6	21	4.5	3.4	3	28.22
48203149	M5x0.8	6HX	70	6.4	25	6	4.9	3	29.03
48203155	M6x1	6HX	80	8	30	6	4.9	3	29.34
48203161	M8x1.25	6HX	90	10	35	8	6.2	3	35.14
48203169	M10x1.5	6HX	100	12	39	10	8	3	42.89

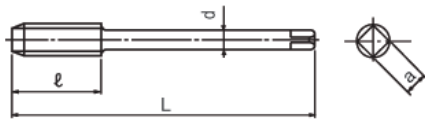

Unit:mm

METRIC DIN 376

EDP NO.	Thread Size	TAP Limit	L	ℓ	ℓ1	d	a	Z	List Price (USD)
48203179	M12x1.75	6HX	110	14	-	9	7	3	54.00
48203191	M14x2	6HX	110	16	-	11	9	3	64.40
48203202	M16x2	6HX	110	16	-	12	9	3	75.64

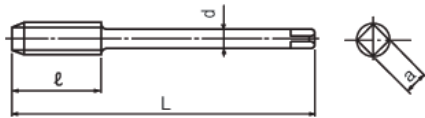

Unit:mm

METRIC DIN 374

EDP NO.	Thread Size	TAP Limit	L	ℓ	ℓ1	d	a	Z	List Price (USD)
48203162	M8x1	6HX	90	10	-	6	4.9	3	38.65
48203171	M10x1	6HX	90	10	-	7	5.5	3	55.76
48203170	M10x1.25	6HX	100	12	-	7	5.5	3	47.16
48203181	M12x1.25	6HX	100	14	-	9	7	3	64.80
48203180	M12x1.5	6HX	100	14	-	9	7	3	59.40

Work Material Abbreviation	Carbon Steels				Alloy Steels	Hardened Steels				Stainless Steels	Tool Steels	Cast Steels	Cast Iron	Ductile Cast Iron	Copper	Brass	Brass Casting	Bronze	Aluminum Rolled	Aluminum Alloy Casting	Magnesium Alloy Casting	Zinc Alloy Casting	Titanium Alloy	Nickel Alloy	Thermo Setting Plastic	Thermo Plastic
	Low Carbon Steels	Medium Carbon Steels	High Carbon Steels	Alloy Steels		25-35 HRC	35-45 HRC	45-50 HRC	50-60 HRC																	
A-SFT (FORM E)	○	○	○	○	○					○	○	○		○	○	○	○	○	○	○	○	○	○	○	○	○

DIN GENERAL & SUS APPLICATION

VA-POT

General application tap in DIN series. Suitable for carbon steel, alloy steel, mild steel, and stainless steel in through hole application.

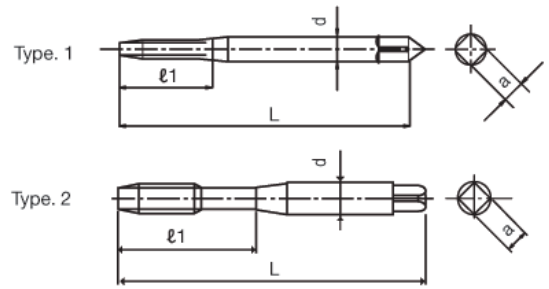

METRIC DIN 371

Unit:mm

EDP NO.	Thread Size	TAP Limit	L	ℓ	d	a	Z	Type	List Price (USD)
63812560	M2 x 0.4	6H	45	8	2.8	2.1	2	1	20.44
63812860	M2.2 x 0.45	6H	45	9	2.8	2.1	2	1	20.17
63813360	M2.5 x 0.45	6H	50	9	2.8	2.1	2	1	20.03
63813860	M3 x 0.5	6H	56	18	3.5	2.7	3	2	17.69
63814060	M3.5 x 0.6	6H	56	20	4	3	3	2	18.58
63814460	M4 x 0.7	6H	63	21	4.5	3.4	3	2	18.04
63814960	M5 x 0.8	6H	70	25	6	4.9	3	2	18.72
63815560	M6 x 1	6H	80	30	6	4.9	3	2	18.90
63816160	M8 x 1.25	6H	90	35	8	6.2	3	2	21.79
63816960	M10 x 1.5	6H	100	39	10	8	3	2	27.41

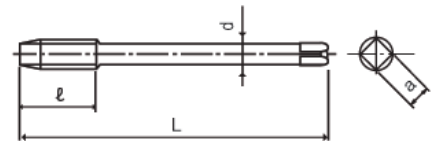

METRIC FINE DIN 374

Unit:mm

EDP NO.	Thread Size	TAP Limit	L	ℓ	d	a	Z	List Price (USD)
63713960	M3 x 0.35	6H	56	9	2.2	-	3	26.38
63714560	M4 x 0.5	6H	63	10	2.8	2.1	3	26.38
63715160	M5 x 0.5	6H	70	12	3.5	2.7	3	27.41
63715760	M6 x 0.5	6H	80	14	4.5	3.4	3	26.73
63715660	M6 x 0.75	6H	80	14	4.5	3.4	3	28.30
63716360	M8 x 0.75	6H	80	18	6	4.9	3	28.17
63716260	M8 x 1	6H	90	22	6	4.9	3	30.46
63717160	M10 x 1	6H	90	20	7	5.5	3	42.85
63717060	M10 x 1.25	6H	100	24	7	5.5	3	37.45
63718260	M12 x 1	6H	100	22	9	7	3	35.96
63718160	M12 x 1.25	6H	100	22	9	7	3	36.13
63718060	M12 x 1.5	6H	100	22	9	7	3	35.96
63719260	M14 x 1.5	6H	100	22	11	9	3	53.65
63720360	M16 x 1.5	6H	100	22	12	9	3	62.02
63721660	M18 x 1.5	6H	110	25	14	11	3	77.49
63723060	M20 x 1.5	6H	125	25	16	12	3	79.25
63724060	M22 x 1.5	6H	125	25	18	14.5	3	99.23
63725060	M24 x 1.5	6H	140	28	18	14.5	3	105.84

Work Material Abbreviation	Low Carbon Steels			Medium Carbon Steels	High Carbon Steels	Alloy Steels	Hardened Steels			Stainless Steels	Tool Steels	Cast Steels	Cast Iron	Ductile Cast Iron	Copper	Brass	Brass Casting	Bronze	Aluminum Rolled	Aluminum Alloy Casting	Magnesium Alloy Casting	Zinc Alloy Casting	
	C ~0.25%	C0.25% ~0.45%	C 0.45% ~			SCM	25 ~ 45 HRC	45 ~ 55 HRC	50 ~ 60 HRC	SUS	SKD	SC	FC	FCD	Cu	Bs	BsC	PB	AL	AC,ADC	MC	ZDC	
VA-POT	○	○	○	○	○	○				○	○	○		○	○								

General application tap in DIN series. Suitable for carbon steel, alloy steel, mild steel, and stainless steel in through hole application.

DIN GENERAL & SUS APPLICATION

VA-POT

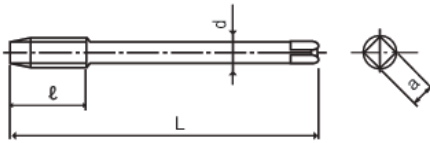

METRIC DIN 376

Unit:mm

EDP NO.	Thread Size	TAP Limit	L	l	d	a	Z	List Price (USD)
63917960	M12 x 1.75	6H	110	28	9	7	3	33.70
63919160	M14 x 2	6H	110	30	11	9	3	41.90
63920260	M16 x 2	6H	110	32	12	9	3	49.28
63921460	M18 x 2.5	6H	125	34	14	11	3	66.56
63922860	M20 x 2.5	6H	140	34	16	12	3	78.79
63923860	M22 x 2.5	6H	140	34	18	14.5	3	86.40
63924760	M24 x 3	6H	160	38	18	14.5	3	105.84
63926260	M27 x 3	6H	160	38	20	16	4	137.43
63927160	M30 x 3.5	6H	180	45	22	18	4	164.43
63928160	M33 x 3.5	6H	180	50	25	20	4	189.54
63929460	M36 x 4	6H	200	56	28	22	4	220.54

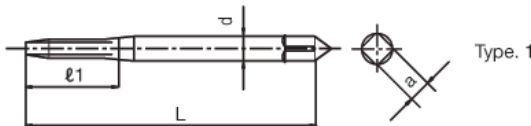

Type 1

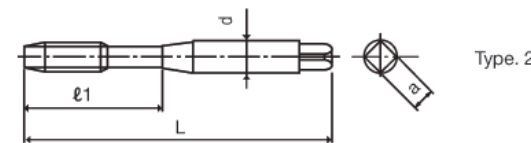

Type 2



METRIC DIN 371

Unit:mm

EDP NO.	Thread Size	TAP Limit	L	l1	d	a	Z	Type	List Price (USD)
63812599	M2 x 0.4	6G	45	8	2.8	2.1	2	1	23.54
63813399	M2.5 x 0.45	6G	50	9	2.8	2.1	2	1	23.09
63813899	M3 x 0.5	6G	56	18	3.5	2.7	3	2	20.39
63814499	M4 x 0.7	6G	63	21	4.5	3.4	3	2	20.71
63814999	M5 x 0.8	6G	70	25	6	4.9	3	2	21.55
63815599	M6 x 1	6G	80	30	6	4.9	3	2	21.79
63816199	M8 x 1.25	6G	90	35	8	6.2	3	2	25.11
63816999	M10 x 1.5	6G	100	39	10	8	3	2	31.46

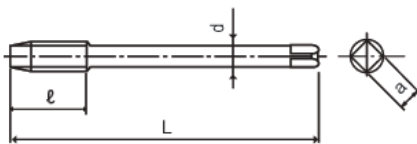

METRIC DIN 376

Unit:mm

EDP NO.	Thread Size	TAP Limit	L	l	d	a	Z	List Price (USD)
63917999	M12 x 1.75	6G	110	28	9	7	3	38.88
63919199	M14 x 2	6G	110	30	11	9	3	48.28
63920299	M16 x 2	6G	110	32	12	9	3	56.65

Work Material Abbreviation	Low Carbon Steels			Medium Carbon Steels	High Carbon Steels	Alloy Steels	Hardened Steels			Stainless Steels	Tool Steels	Cast Steels	Cast Iron	Ductile Cast Iron	Copper	Brass	Brass Casting	Bronze	Aluminum Rolled	Aluminum Alloy Casting	Magnesium Alloy Casting	Zinc Alloy Casting
	C ~ 0.25%	CO.25% ~ 0.45%	C 0.45% ~			SCM	25 ~ 45 HRC	45 ~ 55 HRC	50 ~ 60 HRC	SUS	SKD	SC	FC	FCD	Cu	Bs	BsC	PB	AL	AC,ADC	MC	ZDC
VA-POT	○	○	○	○	○	○				○	○	○		○	○							

General application tap in DIN series. Suitable for carbon steel, alloy steel, mild steel, and stainless steel in through hole application.

DIN GENERAL & SUS APPLICATION

VA-POT

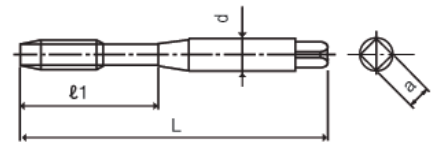

Unit:mm



UNC DIN 2184-1

EDP NO.	Thread Size	TAP Limit	L	l1	d	a	Z	List Price (USD)
74845720	4-40 UNC	2B	56	18	3.5	2.7	2	21.82
74845920	5-40 UNC	2B	56	18	3.5	2.7	3	21.82
74846130	6-32 UNC	2B	56	20	4	3	3	20.79
74846430	8-32 UNC	2B	63	21	4.5	3.4	3	20.79
74846630	10-24 UNC	2B	70	25	6	4.9	3	21.82
74847150	1/4-20 UNC	2B	80	30	7	5.5	3	23.49
74847450	5/16-18 UNC	2B	90	35	8	6.2	3	26.60
74847950	3/8-16 UNC	2B	90	35	9	7	3	29.48

(Formerly was DIN 2182. No change of specifications)

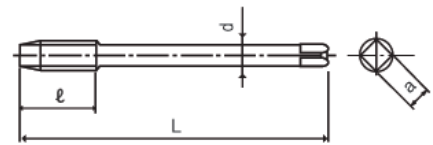

Unit:mm



UNC DIN 2184-1

EDP NO.	Thread Size	TAP Limit	L	l	d	a	Z	List Price (USD)
75148450	7/16-14 UNC	2B	100	24	8	6.2	3	36.13
75148950	1/2-13 UNC	2B	110	29	9	7	3	39.64
75149450	9/16-12 UNC	2B	110	30	11	9	3	44.28
75150150	5/8-11 UNC	2B	110	32	12	9	3	48.96
75151550	3/4-10 UNC	2B	125	34	14	11	3	66.56
75152660	7/8-9 UNC	2B	140	34	18	14.5	3	80.41
75153860	1-8 UNC	2B	160	38	18	14.5	3	105.52

(Formerly was DIN 2183. No change of specifications)

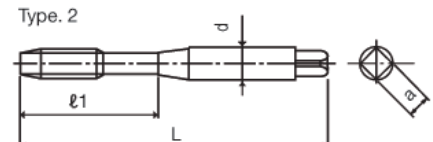
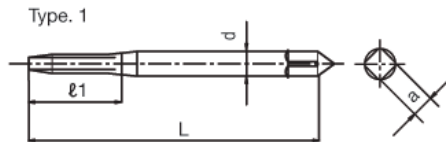

Unit:mm



UNF DIN 2184-1

EDP NO.	Thread Size	TAP Limit	L	l1	d	a	Z	Type	List Price (USD)
75146220	6-40 UNF	2B	56	13	4	3	3	1	29.03
75146730	10-32 UNF	2B	70	25	6	4.9	3	2	29.84
75147240	1/4-28 UNF	2B	80	30	7	5.5	3	2	32.45
75147640	5/16-24 UNF	2B	90	35	8	6.2	3	2	34.83
75148140	3/8-24 UNF	2B	90	35	9	7	3	2	37.72

(Formerly was DIN 2182. No change of specifications)

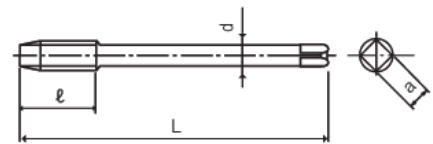

Unit:mm



UNF DIN 2184-1

EDP NO.	Thread Size	TAP Limit	L	l	d	a	Z	List Price (USD)
75148650	7/16-20 UNF	2B	100	20	8	6.2	3	47.66
75149150	1/2-20 UNF	2B	100	22	9	7	3	45.14
75149650	9/16-18 UNF	2B	100	22	11	9	3	53.46
75150450	5/8-18 UNF	2B	100	22	12	9	3	61.65
75151750	3/4-16 UNF	2B	110	25	14	11	3	79.57
75152860	7/8-14 UNF	2B	125	25	18	14.5	3	101.07
75153960	1-12 UNF	2B	125	25	18	14.5	3	134.11

(Formerly was DIN 2183. No change of specifications)

General application tap in DIN series. Suitable for carbon steel, alloy steel, mild steel, and stainless steel in through hole application.

DIN GENERAL & SUS APPLICATION

VA-POT

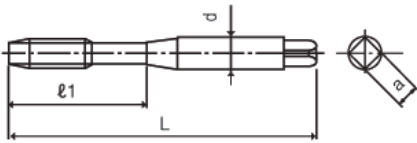

UNJC DIN 2184-1

Unit:mm

EDP NO.	Thread Size	TAP Limit	L	l1	d	a	Z	List Price (USD)
48002457	4-40 UNJC	3B	56	18	3.5	2.7	2	26.15
48002461	6-32 UNJC	3B	56	20	4	3	3	24.93
48002464	8-32 UNJC	3B	63	21	4.5	3.4	3	24.93

(Formerly was DIN 2182. No change of specifications)

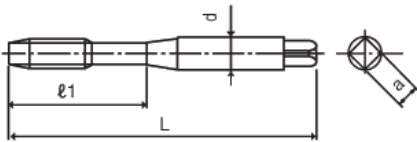

UNJF DIN 2184-1

Unit:mm

EDP NO.	Thread Size	TAP Limit	L	l1	d	a	Z	List Price (USD)
48002467	10-32 UNJF	3B	70	25	6	4.9	3	35.68
48002472	1/4-28 UNJF	3B	80	30	7	5.5	3	38.92
48002476	5/16-24 UNJF	3B	90	35	8	6.2	3	41.72
48002481	3/8-24 UNJF	3B	90	35	9	7	3	45.13

(Formerly was DIN 2182. No change of specifications)

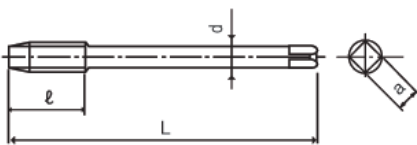

UNJF DIN 2184-1

Unit:mm

EDP NO.	Thread Size	TAP Limit	L	l	d	a	Z	List Price (USD)
48002486	7/16-20 UNJF	3B	100	20	8	6.2	3	57.15
48002491	1/2-20 UNJF	3B	100	22	9	7	3	54.14

(Formerly was DIN 2183. No change of specifications)

Work Material Abbreviation	Low Carbon Steels	Medium Carbon Steels	High Carbon Steels	Alloy Steels	Hardened Steels			Stainless Steels	Tool Steels	Cast Steels	Cast Iron	Ductile Cast Iron	Copper	Brass	Brass Casting	Bronze	Aluminum Rolled	Aluminum Alloy Casting	Magnesium Alloy Casting	Zinc Alloy Casting
	C ~ 0.25%	C0.25% ~ 0.45%	C 0.45% ~	SCM	25 ~ 45 HRC	45 ~ 55 HRC	50 ~ 60 HRC	SUS	SKD	SC	FC	FCD	Cu	Bs	BsC	PB	AL	AC,ADC	MC	ZDC
VA-POT	○	○	○	○				○	○	○		○	○							

DIN GENERAL & SUS APPLICATION

VA-SFT

General application tap in DIN series. Suitable for carbon steel, alloy steel, mild steel, and stainless steel in through hole application.

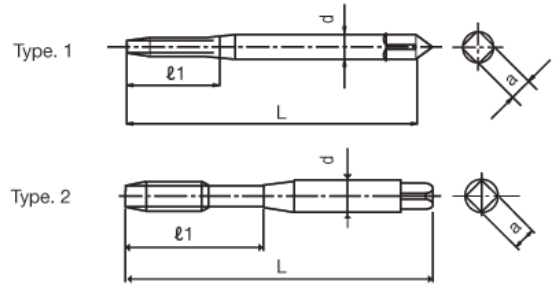

METRIC DIN 371

Unit:mm

EOP NO.	Thread Size	TAP Limit	L	ℓ1	d	a	Z	Type	List Price (USD)
65312560	M2 x 0.4	6H	45	8	2.8	2.1	2	1	20.57
65312860	M2.2 x 0.45	6H	45	9	2.8	2.1	2	1	22.01
65313360	M2.5 x 0.45	6H	50	9	2.8	2.1	2	1	21.92
65313860	M3 x 0.5	6H	58	18	3.5	2.7	3	2	19.09
65314060	M3.5 x 0.6	6H	56	20	4	3	3	2	19.90
65314460	M4 x 0.7	6H	63	21	4.5	3.4	3	2	19.44
65314960	M5 x 0.8	6H	70	25	6	4.9	3	2	20.17
65315560	M6 x 1	6H	80	30	8	4.9	3	2	20.34
65316160	M8 x 1.25	6H	90	35	8	6.2	3	2	23.44
65316960	M10 x 1.5	6H	100	39	10	8	3	2	29.43

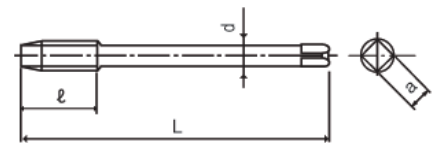

METRIC FINE DIN 374

Unit:mm

EOP NO.	Thread Size	TAP Limit	L	ℓ	d	a	Z	List Price (USD)
65513960	M3 x 0.35	6H	56	4	2.2	-	3	28.57
65514560	M4 x 0.5	6H	63	6	2.8	2.1	3	28.57
65515160	M5 x 0.5	6H	70	7	3.5	2.7	3	29.43
65515760	M6 x 0.5	6H	80	8	4.5	3.4	3	29.43
65515660	M6 x 0.75	6H	80	8	4.5	3.4	3	28.71
65516360	M8 x 0.75	6H	80	10	6	4.9	3	30.33
65516260	M8 x 1	6H	90	10	6	4.9	3	30.46
65517160	M10 x 1	6H	90	12	7	5.5	4	32.99
65517060	M10 x 1.25	6H	100	12	7	5.5	4	32.99
65518260	M12 x 1	6H	100	14	9	7	4	38.75
65518160	M12 x 1.25	6H	100	14	9	7	4	38.93
65518060	M12 x 1.5	6H	100	14	9	7	4	38.75
65519260	M14 x 1.5	6H	100	16	11	9	4	49.90
65520360	M16 x 1.5	6H	100	16	12	9	5	57.83
65521660	M18 x 1.5	6H	110	20	14	11	5	66.64
65523060	M20 x 1.5	6H	125	20	16	12	5	83.52
65524060	M22 x 1.5	6H	125	20	18	14.5	5	90.32
65525060	M24 x 1.5	6H	140	24	18	14.5	5	113.18

Work Material	Low Carbon Steels		Medium Carbon Steels	High Carbon Steels	Alloy Steels	Hardened Steels			Stainless Steels	Tool Steels	Cast Steels	Cast Iron	Ductile Cast Iron	Copper	Brass	Brass Casting	Bronze	Aluminum Rolled	Aluminum Alloy Casting	Magnesium Alloy Casting	Zinc Alloy Casting
	C	C0.25%	C0.25% ~ 0.45%	C		25 ~ 45 HRC	45 ~ 55 HRC	50 ~ 60 HRC													
Abbreviation	-0.25%	~0.45%	0.45% ~	SCM				SUS	SKD	SC	FC	FCD	Cu	Bs	BsC	PB	AL	AC,ADC	MC	ZDC	
VA-SFT	○	○	○	○				○	○	○			○	○							

General application tap in DIN series. Suitable for carbon steel, alloy steel, mild steel, and stainless steel in through hole application.

DIN GENERAL & SUS APPLICATION

VA-SFT

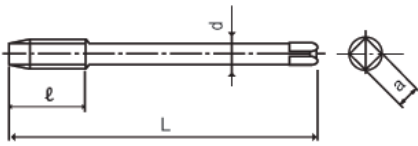

Unit:mm

METRIC DIN 376

EDP NO.	Thread Size	TAP Limit	L	ℓ	d	a	Z	List Price (USD)
65417960	M12 x 1.75	6H	110	18	9	7	4	36.27
65419160	M14 x 2	6H	110	20	11	9	4	45.14
65420260	M16 x 2	6H	110	20	12	9	4	52.97
65421460	M18 x 2.5	6H	125	25	14	11	4	71.60
65422860	M20 x 2.5	6H	140	25	16	12	4	84.83
65423860	M22 x 2.5	6H	140	25	18	14.5	4	92.48
65424760	M24 x 3	6H	160	30	18	14.5	4	113.59
65426260	M27 x 3	6H	160	30	20	16	5	147.91
65427160	M30 x 3.5	6H	180	35	22	18	5	177.88
65428160	M33 x 3.5	6H	180	35	25	20	5	203.36
65429460	M36 x 4	6H	200	40	28	22	5	237.82

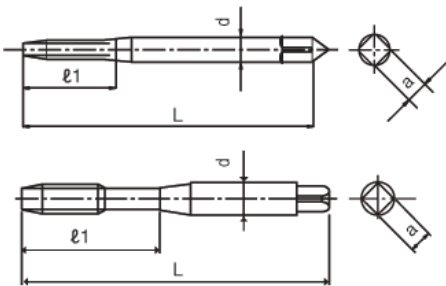

Type. 1

Type. 2



Type. 1

Type. 2



Unit:mm

METRIC DIN 371

EDP NO.	Thread Size	TAP Limit	L	ℓ1	d	a	Z	Type	List Price (USD)
65312599	M2 x 0.4	6G	45	8	2.8	2.1	2	1	23.54
65313399	M2.5 x 0.45	6G	50	9	2.8	2.1	2	1	25.25
65313899	M3 x 0.5	6G	56	18	3.5	2.7	3	2	21.92
65314499	M4 x 0.7	6G	63	21	4.5	3.4	3	2	22.33
65314999	M5 x 0.8	6G	70	25	6	4.9	3	2	23.27
65315599	M6 x 1	6G	80	30	8	4.9	3	2	23.44
65316199	M8 x 1.25	6G	90	35	8	6.2	3	2	26.95
65316999	M10 x 1.5	6G	100	39	10	8	3	2	33.80

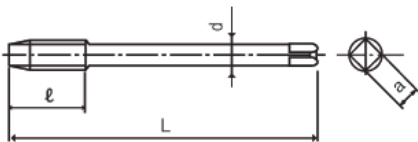

Unit:mm

METRIC DIN 371

EDP NO.	Thread Size	TAP Limit	L	ℓ	d	a	Z	List Price (USD)
65417999	M12 x 1.75	6G	110	18	9	7	4	41.80
65419199	M14 x 2	6G	110	20	11	9	4	51.89
65420299	M16 x 2	6G	110	20	12	9	4	61.02

Work Material Abbreviation	Low Carbon Steels			Medium Carbon Steels	High Carbon Steels	Alloy Steels	Hardened Steels			Stainless Steels	Tool Steels	Cast Steels	Cast Iron	Ductile Cast Iron	Copper	Brass	Brass Casting	Bronze	Aluminum Rolled	Aluminum Alloy Casting	Magnesium Alloy Casting	Zinc Alloy Casting
	C ~0.25%	C0.25% ~0.45%	C 0.45% ~	SCM	25 ~ 45 HRC		45 ~ 55 HRC	50 ~ 60 HRC	SUS													
VA-SFT	○	○	○	○					○	○	○			○	○							

DIN GENERAL & SUS APPLICATION

VA-SFT

General application tap in DIN series. Suitable for carbon steel, alloy steel, mild steel, and stainless steel in through hole application.

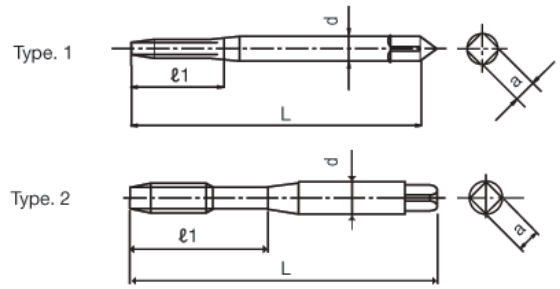

UNC DIN 2184-1

Unit:mm

EDP NO.	Thread Size	TAP Limit	L	ℓ1	d	a	Z	Type	List Price (USD)
74945730	4-40 UNC	2B	56	11	3.5	2.7	2	1	27.41
74945930	5-40 UNC	2B	56	18	3.5	2.7	3	2	27.41
74946130	6-32 UNC	2B	56	20	4	3	3	2	25.87
74946430	8-32 UNC	2B	63	21	4.5	3.4	3	2	25.87
74946630	10-24 UNC	2B	70	25	6	4.9	3	2	27.41
74947150	1/4-20 UNC	2B	80	30	7	5.5	3	2	30.33
74947450	5/16-18 UNC	2B	90	35	8	6.2	3	2	31.68
74947950	3/8-16 UNC	2B	90	35	9	7	3	2	35.15

(Formerly was DIN 2182. No change of specifications)

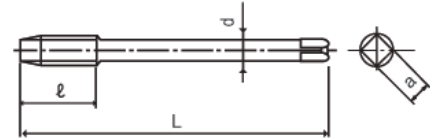

UNC DIN 2184-1

Unit:mm

EDP NO.	Thread Size	TAP Limit	L	ℓ	d	a	Z	List Price (USD)
75248450	7/16-14 UNC	2B	100	19	8	6.2	4	46.22
75248950	1/2-13 UNC	2B	110	20	9	7	4	48.06
75249450	9/16-12 UNC	2B	110	22	11	9	4	56.08
75250150	5/8-11 UNC	2B	110	24	12	9	4	64.13
75251550	3/4-10 UNC	2B	125	26	14	11	4	79.57
75252660	7/8-9 UNC	2B	140	29	18	14.5	4	101.07
75253860	1-8 UNC	2B	160	32	18	14.5	5	134.11

(Formerly was DIN 2183. No change of specifications)

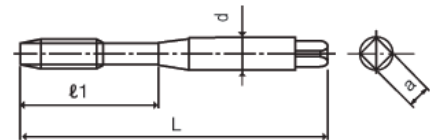

UNF DIN 2184-1

Unit:mm

EDP NO.	Thread Size	TAP Limit	L	ℓ1	d	a	Z	List Price (USD)
75246220	6-40 UNF	2B	56	20	4	3	3	30.60
75246730	10-32 UNF	2B	70	25	6	4.9	3	31.68
75247240	1/4-28 UNF	2B	80	30	7	5.5	3	35.91
75247640	5/16-24 UNF	2B	90	35	8	6.2	3	37.72
75248140	3/8-24 UNF	2B	90	35	9	7	3	38.56

(Formerly was DIN 2182. No change of specifications)

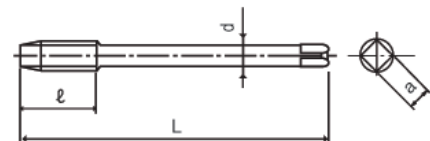

UNF DIN 2184-1

Unit:mm

EDP NO.	Thread Size	TAP Limit	L	ℓ	d	a	Z	List Price (USD)
75248650	7/16-20 UNF	2B	100	20	8	6.2	3	49.82
75249150	1/2-20 UNF	2B	100	22	9	7	3	49.19
75249650	9/16-18 UNF	2B	100	22	11	9	3	57.38
75250450	5/8-18 UNF	2B	100	22	12	9	3	65.61
75251750	3/4-16 UNF	2B	110	25	14	11	3	84.73
75252860	7/8-14 UNF	2B	125	25	18	14.5	3	104.00
75253960	1-12 UNF	2B	125	25	18	14.5	3	144.77

(Formerly was DIN 2183. No change of specifications)

General application tap in DIN series. Suitable for carbon steel, alloy steel, mild steel, and stainless steel in through hole application.

DIN GENERAL & SUS APPLICATION

VA-SFT

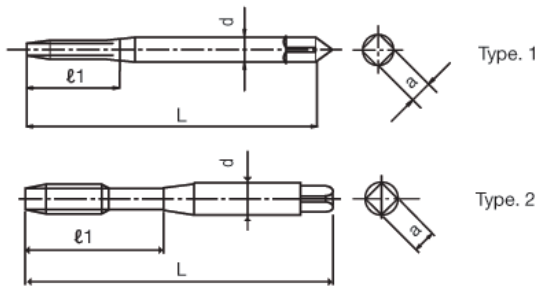

Unit:mm

UNJC DIN 2184-1

EDP NO.	Thread Size	TAP Limit	L	l1	d	a	Z	Type	List Price (USD)
48001457	4-40 UNJC	3B	56	11	3.5	2.7	2	1	32.85
48001461	6-32 UNJC	3B	56	20	4	3	3	2	31.14
48001464	8-32 UNJC	3B	63	21	4.5	3.4	3	2	31.14

(Formerly was DIN 2182. No change of specifications)

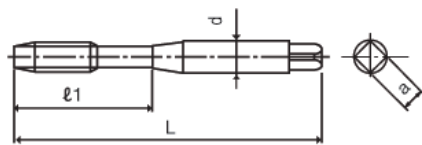

Unit:mm

UNJF DIN 2184-1

EDP NO.	Thread Size	TAP Limit	L	l1	d	a	Z	List Price (USD)
48001467	10-32 UNJF	3B	70	25	6	4.9	3	38.03
48001472	1/4-28 UNJF	3B	80	30	7	5.5	3	42.89
48001476	5/16-24 UNJF	3B	90	35	8	6.2	3	45.13
48001481	3/8-24 UNJF	3B	90	35	9	7	3	46.08

(Formerly was DIN 2182. No change of specifications)

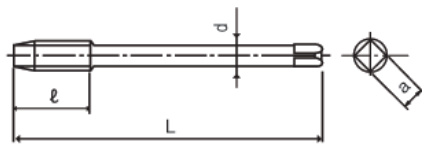

Unit:mm

UNJF DIN 2184-1

EDP NO.	Thread Size	TAP Limit	L	l	d	a	Z	List Price (USD)
48001486	7/16-20 UNJF	3B	100	15	8	6.2	4	59.76
48001491	1/2-20 UNJF	3B	100	16	9	7	4	58.90

(Formerly was DIN 2183. No change of specifications)

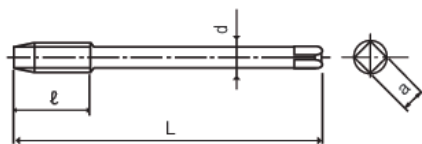

Unit:mm

G THREAD DIN 5156

EDP NO.	Thread Size	TAP Limit	L	l	d	a	Z	List Price (USD)
65881909	G1/8-28	-	90	11	7	5.5	4	49.46
65882009	G1/4-19	-	100	16	11	9	4	66.74
65882109	G3/8-19	-	100	16	12	9	5	83.75
65882209	G1/2-14	-	125	22	16	12	5	116.78
65882309	G5/8-14	-	125	22	18	14.5	5	143.51
65882409	G3/4-14	-	140	22	20	16	5	190.54
65882509	G7/8-14	-	150	22	22	18	5	241.65
65882609	G1-11	-	160	28	25	20	5	270.49

Work Material Abbreviation	Work Material				Hardened Steels			Stainless Steels	Tool Steels	Cast Steels	Cast Iron	Ductile Cast Iron	Copper	Brass	Brass Casting	Bronze	Aluminum Rolled	Aluminum Alloy Casting	Magnesium Alloy Casting	Zinc Alloy Casting	
	Low Carbon Steels	Medium Carbon Steels	High Carbon Steels	Alloy Steels	25 ~ 45 HRC	45 ~ 55 HRC	50 ~ 60 HRC	SUS	SKD	SC	FC	FCD	Cu	Bs	BsC	PB	AL	AC,ADC	MC	ZDC	
VA-SFT	○	○	○	○				○	○	○			○	○							

DIN GENERAL & SUS APPLICATION

VA-SFT (FORM E)

(Formerly was VA-SC-SFT)

General application tap in DIN series. Suitable for carbon steel, alloy steel, mild steel, and stainless steel in through hole application.

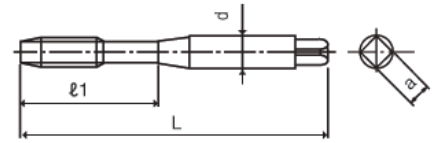

METRIC DIN 371

Unit:mm

EDP NO.	Thread Size	TAP Limit	L	l1	d	a	Z	List Price (USD)
48036138	M3 x 0.5	6H	56	18	3.5	2.7	3	19.80
48036144	M4 x 0.7	6H	63	21	4.5	3.4	3	20.17
48036149	M5 x 0.8	6H	70	25	6	4.9	3	20.88
48036155	M6 x 1	6H	80	30	6	4.9	3	21.06
48036161	M8 x 1.25	6H	90	35	8	6.2	3	24.30
48036169	M10 x 1.5	6H	100	39	10	8	3	30.56

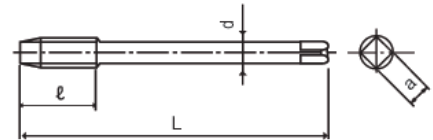

METRIC DIN 376

Unit:mm

EDP NO.	Thread Size	TAP Limit	L	l	d	a	Z	List Price (USD)
48036179	M12 x 1.75	6H	110	18	9	7	3	37.67
48036191	M14 x 2	6H	110	20	11	9	3	46.85
48036202	M16 x 2	6H	110	20	12	9	3	55.00

Abbreviation	Work Material		Alloy Steels	Hardened Steels			Stainless Steels	Tool Steels	Cast Steels	Cast Iron	Ductile Cast Iron	Copper	Brass	Brass Casting	Bronze	Aluminum Rolled	Aluminum Alloy Casting	Magnesium Alloy Casting	Zinc Alloy Casting
	Low Carbon Steels	Medium Carbon Steels		High Carbon Steels	25 ~ 45 HRC	45 ~ 55 HRC													
VA-SFT (FORM E)	C ~ 0.25%	C0.25% ~ 0.45%	C 0.45% ~	SCM			SUS	SKD	SC	FC	FCD	Cu	Bs	BsC	PB	AL	AC,ADC	MC	ZDC
	○	○	○	○			○	○	○		○	○							

General application tap in DIN series. Suitable for carbon steel, alloy steel, mild steel, and stainless steel in through hole application.

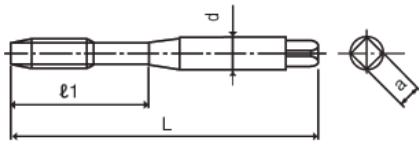

Unit:mm

EDP NO.	Thread Size	TAP Limit	L	ℓ1	d	a	Z	List Price (USD)
48092138	M3 x 0.5	6H	56	18	3.5	2.7	3	13.18
48092144	M4 x 0.7	6H	63	21	4.5	3.4	3	12.56
48092149	M5 x 0.8	6H	70	25	6	4.9	3	12.96
48092155	M6 x 1	6H	80	30	6	4.9	3	13.72
48092161	M8 x 1.25	6H	90	35	8	6.2	3	20.20
48092169	M10 x 1.5	6H	100	39	10	8	3	25.74



METRIC DIN 371

DIN GENERAL TAP

POT

HSS TAPS DIN

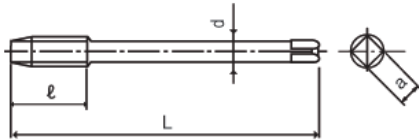

Unit:mm

EDP NO.	Thread Size	TAP Limit	L	ℓ	d	a	Z	List Price (USD)
48092179	M12 x 1.75	6H	110	28	9	7	3	33.70
48092191	M14 x 2	6H	110	30	11	9	3	41.90
48092202	M16 x 2	6H	110	32	12	9	3	49.28
48092214	M18 x 2.5	6H	125	34	14	11	3	66.56
48092228	M20 x 2.5	6H	140	34	16	12	3	78.79
48092238	M22 x 2.5	6H	140	34	18	14.5	3	86.40
48092247	M24 x 3	6H	160	38	18	14.5	3	105.84



METRIC DIN 376

DIN GENERAL TAP

SFT

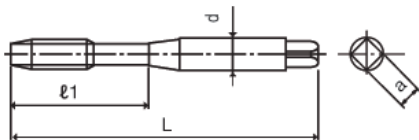

Unit:mm

EDP NO.	Thread Size	TAP Limit	L	ℓ1	d	a	Z	List Price (USD)
48091138	M3 x 0.5	6H	56	18	3.5	2.7	3	13.59
48091144	M4 x 0.7	6H	63	21	4.5	3.4	3	13.01
48091149	M5 x 0.8	6H	70	25	6	4.9	3	13.42
48091155	M6 x 1	6H	80	30	6	4.9	3	14.26
48091161	M8 x 1.25	6H	90	35	8	6.2	3	21.01
48091169	M10 x 1.5	6H	100	39	10	8	3	26.41



METRIC DIN 371

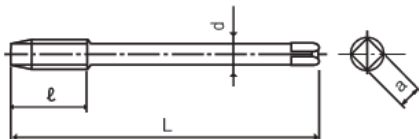

Unit:mm

EDP NO.	Thread Size	TAP Limit	L	ℓ	d	a	Z	List Price (USD)
48091179	M12 x 1.75	6H	110	18	9	7	3	36.27
48091191	M14 x 2	6H	110	20	11	9	3	45.14
48091202	M16 x 2	6H	110	20	12	9	3	52.97
48091214	M18 x 2.5	6H	125	25	14	11	3	71.60
48091228	M20 x 2.5	6H	140	25	16	12	3	84.83
48091238	M22 x 2.5	6H	140	25	18	14.5	3	92.48
48091247	M24 x 3	6H	160	30	18	14.5	3	113.59



METRIC DIN 376

Work Material Abbreviation	Low Carbon Steels		Medium Carbon Steels	High Carbon Steels	Alloy Steels	Hardened Steels			Stainless Steels	Tool Steels	Cast Steels	Cast Iron	Ductile Cast Iron	Copper	Brass	Brass Casting	Bronze	Aluminum Rolled	Aluminum Alloy Casting	Magnesium Alloy Casting	Zinc Alloy Casting
	C ~0.25%	CO.25% ~0.45%	C 0.45% ~	SCM	25 ~ 45 HRC	45 ~ 55 HRC	50 ~ 60 HRC	SUS	SKD	SC	FC	FCD	Cu	Bs	BsC	PB	AL	AC,ADC	MC	ZDC	
POT	○	○	○	○						○			○	○	○	○	○	○	○	○	○
SFT	○	○	○	○						○			○	○	○	○	○	○	○	○	○

DIN CHIP CONTROL TAP

CC-SFT

General application tap in DIN series. Suitable for carbon steel, alloy steel, mild steel, and stainless steel in through hole application.

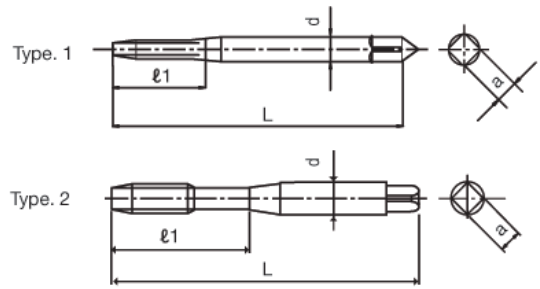
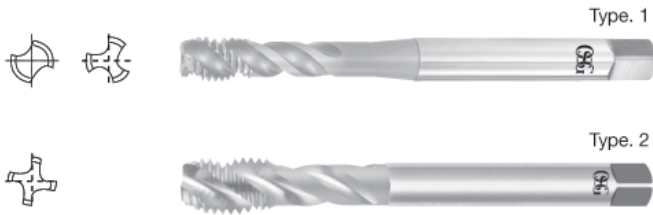

METRIC DIN 371

Unit:mm

EDP NO.	Thread Size	TAP Limit	L	l1	d	a	Z	Type	List Price (USD)
48032125	M2 x 0.4	6HX	45	8	2.8	2.1	2	1	31.78
48032133	M2.5 x 0.45	6HX	50	10	2.8	2.1	2	1	31.41
48032138	M3 x 0.5	6HX	56	12	3.5	2.7	3	1	27.46
48032144	M4 x 0.7	6HX	63	16	4.5	3.4	3	1	28.22
48032149	M5 x 0.8	6HX	70	20	6	4.9	3	1	29.03
48032155	M6 x 1	6HX	80	24	6	4.9	3	1	29.35
48032161	M8 x 1.25	6HX	90	35	6	6.2	3	2	35.15
48032169	M10 x 1.5	6HX	100	39	10	8	4	2	42.88

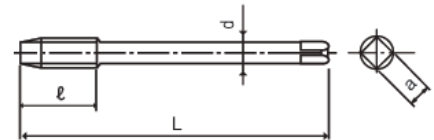

METRIC DIN 376

Unit:mm

EDP NO.	Thread Size	TAP Limit	L	l	d	a	Z	List Price (USD)
48032179	M12 x 1.75	6HX	110	16	9	7	4	54.00
48032191	M14 x 2	6HX	110	18	11	9	4	64.40
48032202	M16 x 2	6HX	110	18	12	9	4	75.65
48032214	M18 x 2.5	6HX	125	23	14	11	4	102.28
48032228	M20 x 2.5	6HX	140	23	16	12	4	121.18
48032247	M24 x 3	6HX	160	27	18	14.5	4	155.93

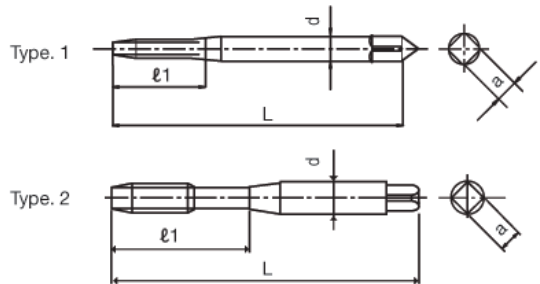

UNJC DIN 2184-1

Unit:mm

EDP NO.	Thread Size	TAP Limit	L	l1	d	a	Z	Type	List Price (USD)
48032464	8-32 UN(J)C	3B	63	16.7	4.5	3.4	3	1	35.24
48032466	10-24 UN(J)C	3B	70	19.3	6	4.9	3	1	37.35
48032471	1/4-20 UN(J)C	3B	80	25.4	7	5.5	3	1	41.31
48032474	5/16-18 UN(J)C	3B	90	13	8	6.2	3	2	43.20
48032479	3/8-16 UN(J)C	3B	100	15	9	7	3	2	47.88

(Formerly was DIN 2182. No change of specifications)

Work Material	Low Carbon Steels			Medium Carbon Steels	High Carbon Steels	Alloy Steels	Hardened Steels			Stainless Steels	Tool Steels	Cast Steels	Cast Iron	Ductile Cast Iron	Copper	Brass	Brass Casting	Bronze	Aluminum Rolled	Aluminum Alloy Casting	Magnesium Alloy Casting	Zinc Alloy Casting
	C	CO.25%	C	CO.25%	C	SCM	25~45 HRC	45~55 HRC	50~60 HRC	SUS	SKD	SC	FC	FCD	Cu	Bs	BsC	PB	AL	AC,ADC	MC	ZDC
CC-SFT	○	○	○	○	○	○				○				○					○			

General application tap in DIN series. Suitable for carbon steel, alloy steel, mild steel, and stainless steel in through hole application.

DIN CHIP CONTROL TAP

CC-SFT

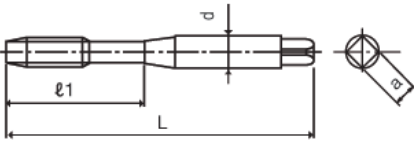

UNJC DIN 2184-1

Unit:mm

EDP NO.	Thread Size	TAP Limit	L	l1	d	a	Z	List Price (USD)
48032484	7/16-14 UN(J)C	3B	100	17	8	6.2	4	62.86
48032489	1/2-13 UN(J)C	3B	110	18	9	7	4	65.43
48032501	5/8-11 UN(J)C	3B	110	21	12	9	4	87.30
48032515	3/4-10 UN(J)C	3B	125	23	14	11	4	108.36
48032526	7/8-9 UN(J)C	3B	140	26	18	14.5	4	151.20
48032538	1-8 UN(J)C	3B	160	29	18	14.5	4	182.39

(Formerly was DIN 2183. No change of specifications)

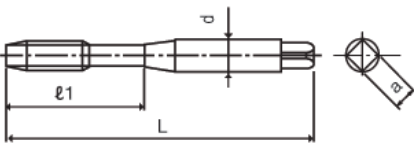

UNJC DIN 2184-1

Unit:mm

EDP NO.	Thread Size	TAP Limit	L	l1	d	a	Z	List Price (USD)
48032467	10-32 UN(J)C	3B	70	19.3	6	4.9	3	51.71
48032472	1/4-28 UN(J)C	3B	80	25.4	7	5.5	3	58.51
48032476	5/16-24 UN(J)C	3B	90	11	8	6.2	3	61.48
48032481	3/8-24 UN(J)C	3B	90	12	9	7	3	62.73

(Formerly was DIN 2182. No change of specifications)

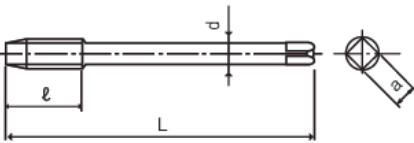

UNJC DIN 2184-1

Unit:mm

EDP NO.	Thread Size	TAP Limit	L	l	d	a	Z	List Price (USD)
48032486	7/16-20	3B	100	14	9	7	4	67.82
48032491	1/2-20	3B	100	15	9	7	4	66.88

(Formerly was DIN 2182. No change of specifications)

DIN CHIP CONTROL TAP

CC-SFT-SPT

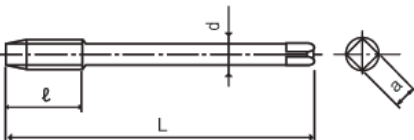

G SERIES DIN 5156

Unit:mm

EDP NO.	Thread Size	TAP Limit	L	l	d	a	Z	List Price (USD)
48034838	G 1/8-28	-	90	10	7	5.5	3	51.62
48034839	G 1/4-19	-	100	15	11	9.0	4	70.93
48034840	G 3/8-19	-	100	15	12	9	4	86.00
48034841	G 1/2-14	-	125	20	16	12	4	120.64

Abbreviation	Work Material										Copper	Brass	Brass Casting	Bronze	Aluminum Rolled	Aluminum Alloy Casting	Magnesium Alloy Casting	Zinc Alloy Casting		
	Low Carbon Steels	Medium Carbon Steels	High Carbon Steels	Alloy Steels	Hardened Steels			Stainless Steels	Tool Steels	Cast Steels									Cast Iron	Ductile Cast Iron
	C ~ 0.25%	CD.25% ~ 0.45%	C 0.45% ~	SCM	25 ~ 45 HRC	45 ~ 55 HRC	50 ~ 60 HRC	SUS	SKD	SC	FC	FCD	Cu	Bs	BsC	PB	AL	AC,ADC	MC	ZDC
CC-SFT	○	○	○	○				○					○				○			
CC-SFT-SPT	○	○	○	○				○					○				○			

DIN CHIP CONTROL TAP

CC-HL-SFT



UNJF DIN 2184-1

Able to tap stainless steel with water soluble coolant. It is also suited for tapping in aluminum alloy and mild steel.

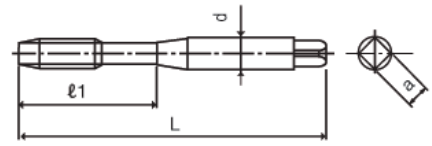

Unit:mm

EDP NO.	Thread Size	TAP Limit	L	l1	d	a	Z	List Price (USD)
48033467	10-32 UN(J)F	3B	80	25.4	7	5.5	3	42.75
48033472	1/4-28 UN(J)F	3B	90	11	8	6.2	3	46.49
48033476	5/16-24 UN(J)F	3B	90	12	9	7.0	3	47.57
48033481	3/8-24 UN(J)F	3B	100	14	11	9	3	75.47

(Formerly was DIN 2182. No change of specifications)

Abbreviation	Work Material			Alloy Steels	Hardened Steels			Stainless Steels	Tool Steels	Cast Steels	Cast Iron	Ductile Cast Iron	Copper	Brass	Brass Casting	Bronze	Aluminum Rolled	Aluminum Alloy Casting	Magnesium Alloy Casting	Zinc Alloy Casting
	Low Carbon Steels	Medium Carbon Steels	High Carbon Steels		25 ~ 45 HRC	45 ~ 55 HRC	50 ~ 60 HRC													
CC-HL-SFT	C ~ 0.25%	C0.25% ~ 0.45%	C 0.45% ~	SCM				SUS	SKD	SC	FC	FCD	Cu	Bs	BsC	PB	AL	AC,ADC	MC	ZDC

DIN FOR NICKEL ALLOY STEELS (AEROSPACE)

WHR-NI-SFT



UNJF DIN 2184-1

High Performance tap for Nickey Alloy Steels(Inconel, Waspalloy) used in Aerospace and Chemical Industries

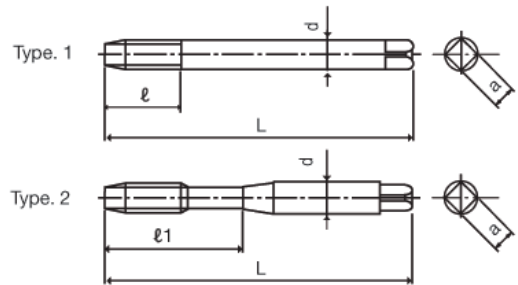

Unit:mm

EDP NO.	Thread Size	TAP Limit	L	l	l1	d	a	Z	Type	List Price (USD)
48078467	10-32 UNJF	3B	70	18	-	6	4.9	3	1	52.38
48078472	1/4-28 UNJF	3B	80	23	-	7	5.5	3	1	56.79
48078476	5/16-24 UNJF	3B	90	-	35	8	6.2	3	2	56.79
48078481	3/8-24 UNJF	3B	90	-	35	10	8	3	2	59.63



UNJF DIN 2184-1

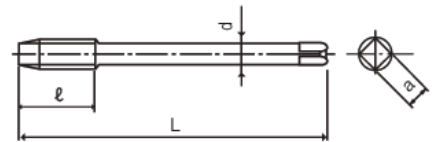

Unit:mm

EDP NO.	Thread Size	TAP Limit	L	l	d	a	Z	Type	List Price (USD)
48078486	7/16-20 UNJF	3B	100	15	8	6.2	3	2	75.10
48078491	1/2-20 UNJF	3B	100	16	9	7	3	2	76.59

Abbreviation	Work Material			Alloy Steels	Hardened Steels			Stainless Steels	Tool Steels	Cast Steels	Cast Iron	Ductile Cast Iron	Copper	Brass	Brass Casting	Bronze	Nickel Alloy	Aluminum Rolled	Aluminum Alloy Casting	Magnesium Alloy Casting	Zinc Alloy Casting
	Low Carbon Steels	Medium Carbon Steels	High Carbon Steels		25 ~ 45 HRC	45 ~ 55 HRC	50 ~ 60 HRC														
WHR-NI-SFT	C ~ 0.25%	C0.25% ~ 0.45%	C 0.45% ~	SCM				SUS	SKD	SC	FC	FCD	Cu	Bs	BsC	PB		AL	AC,ADC	MC	ZDC

Able to tap forged steel and FCD in Automobile Industry

DIN CAST IRON, ADC & STEEL APPLICATIONS

AW-SFT

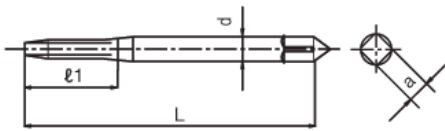

Unit:mm

METRIC DIN 371

EDP NO.	Thread Size	TAP Limit	L	l1	d	a	Z	List Price (USD)
48063149	M5x0.8	6H	70	30	6	4.9	3	20.25
48063155	M6x1	6H	80	40	6	4.9	3	20.44
48063161	M8x1.25	6H	90	36	8	6.2	3	23.54
48063169	M10x1.5	6H	100	44	10	8	3	29.62

(Formerly was DIN 2182. No change of specifications)

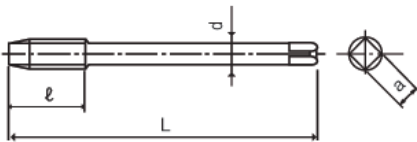

Unit:mm

METRIC DIN 376

EDP NO.	Thread Size	TAP Limit	L	l	d	a	Z	List Price (USD)
48063179	M12x1.75	6H	110	18	9	7	3	36.50
48063191	M14x2	6H	110	20	11	9	3	45.36
48063202	M16x2	6H	110	20	12	9	3	53.28

Unit:mm

METRIC DIN 374

EDP NO.	Thread Size	TAP Limit	L	l	d	a	a	List Price (USD)
48063171	M10x1	6H	90	12	7	5.5	3	33.16
48063170	M10x1.25	6H	100	12	7	5.5	3	33.16
48063181	M12x1.25	6H	100	14	9	7	3	38.93
48063180	M12x1.5	6H	100	14	9	7	3	38.93
48063192	M14x1.5	6H	100	16	11	9	3	50.17
48063203	M16x1.5	6H	100	16	12	9	3	58.19
48063216	M18x1.5	6H	110	20	14	11	4	67.01
48063230	M20x1.5	6H	125	20	16	12	4	84.02

Abbreviation	Work Material			Alloy Steels	Hardened Steels			Stainless Steels	Tool Steels	Cast Steels	Cast Iron	Ductile Cast Iron	Copper	Brass	Brass Casting	Bronze	Aluminum Rolled	Aluminum Alloy Casting	Magnesium Alloy Casting	Zinc Alloy Casting
	Low Carbon Steels	Medium Carbon Steels	High Carbon Steels		25 ~ 45 HRC	45 ~ 55 HRC	50 ~ 60 HRC													
AW-SFT	○	○										○	○					○		

DIN CAST IRON, ADC & STEEL APPLICATIONS

Able to tap forged steel and FCD in Automobile Industry

V-AW-SFT

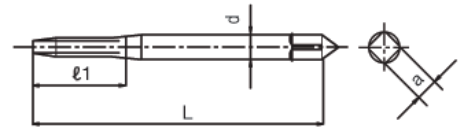

METRIC DIN 371

Unit:mm

EDP NO.	Thread Size	TAP Limit	L	l1	d	a	Z	List Price (USD)
T1503379	M5x0.8	6H	70	30	6	4.9	3	24.75
T1503380	M6x1	6H	80	40	6	4.9	3	24.93
T1503381	M8x1.25	6H	90	36	8	6.2	3	28.04
T1503382	M10x1.5	6H	100	44	10	8	3	36.36

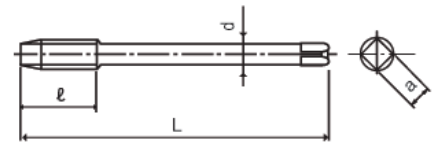

METRIC DIN 376

Unit:mm

EDP NO.	Thread Size	TAP Limit	L	l	d	a	Z	List Price (USD)
T1503383	M12x1.75	6H	110	18	9	7	3	45.50
T1503383	M14x2	6H	110	20	11	9	3	54.36
T1503385	M16x2	6H	110	20	12	9	3	62.28

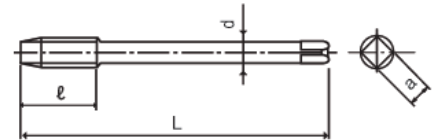

METRIC DIN 374

Unit:mm

EDP NO.	Thread Size	TAP Limit	L	l	d	a	a	List Price (USD)
T1503386	M10x1	6H	90	12	7	5.5	3	36.36
T1503387	M10x1.25	6H	100	12	7	5.5	3	36.36
T1503388	M12x1.25	6H	100	14	9	7	3	45.50
T1503389	M12x1.5	6H	100	14	9	7	3	45.50
T1503390	M14x1.5	6H	100	16	11	9	3	54.36
T1503391	M16x1.5	6H	100	16	12	9	3	62.28
T1503392	M18x1.5	6H	110	20	14	11	4	80.50
T1503393	M20x1.5	6H	125	20	16	12	4	97.51

Abbreviation	Work Material			Alloy Steels	Hardened Steels			Stainless Steels	Tool Steels	Cast Steels	Cast Iron	Ductile Cast Iron	Copper	Brass	Brass Casting	Bronze	Aluminum Rolled	Aluminum Alloy Casting	Magnesium Alloy Casting	Zinc Alloy Casting
	Low Carbon Steels	Medium Carbon Steels	High Carbon Steels		25 ~ 45 HRC	45 ~ 55 HRC	50 ~ 60 HRC													
V-AW-SFT	○	○						○				○	○					○		

High Performance tap for Titanium Alloy Steels (Ti-6Al-4V)
used in Aerospace and Chemical Industries

DIN ALLOY STEEL (AEROSPACE)

V-TI-SFT

HSS TAPS DIN

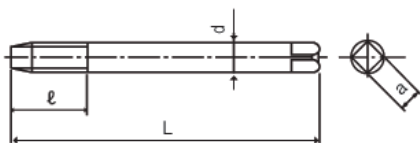

Unit:mm

METRIC DIN 371

EDP NO.	Thread Size	TAP Limit	L	ℓ	d	a	Z	List Price (USD)
48011138	M3x0.5	6H	56	11	3.5	2.7	3	48.96
48011144	M4x0.7	6H	63	14	4.5	3.4	3	51.71
48011149	M5x0.8	6H	70	17	6	4.9	3	52.47
48011155	M6x1.0	6H	80	21	6	4.9	3	53.10
48011161	M8x1.25	6H	90	28	8	6.2	3	61.92
48011169	M10x1.5	6H	100	35	10	8	3	72.40

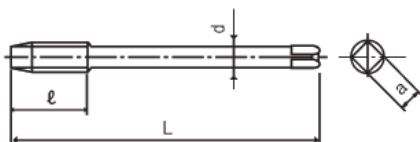

Unit:mm

METRIC DIN 376

EDP NO.	Thread Size	TAP Limit	L	ℓ	d	a	Z	List Price (USD)
48011179	M12x1.75	6H	110	18	10	8	3	94.54

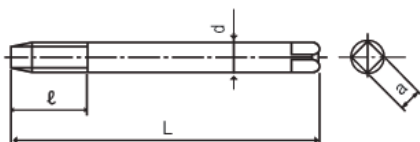

Unit:mm

UNJC DIN 2184-1

EDP NO.	Thread Size	TAP Limit	L	ℓ	d	a	Z	List Price (USD)
48013457	4-40 UNJC	3B	56	10	3.5	2.7	3	65.03
48013461	6-32 UNJC	3B	56	13	4	3	3	60.39
48013464	8-32 UNJC	3B	63	15	4.5	3.4	3	65.57

(Formerly was DIN 2182. No change of specifications)

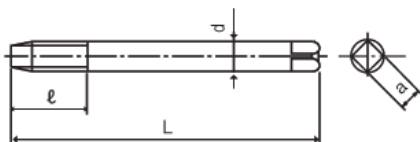

Unit:mm

UNJF DIN 2184-1

EDP NO.	Thread Size	TAP Limit	L	ℓ1	d	a	Z	List Price (USD)
48013467	10-32 UNJF	3B	70	25	6	4.9	3	69.84
48013472	1/4-28 UNJF	3B	80	30	7	5.5	3	76.55
48013476	5/16-24 UNJF	3B	90	35	8	6.2	3	80.46
48013481	3/8-24 UNJF	3B	90	35	10	8	3	85.86

(Formerly was DIN 2182. No change of specifications)

Work Material Abbreviation	Low Carbon Steels	Medium Carbon Steels	High Carbon Steels	Alloy Steels	Hardened Steels			Stainless Steels	Tool Steels	Cast Steels	Cast Iron	Ductile Cast Iron	Copper	Brass	Brass Casting	Titanium	Bronze	Aluminum Rolled	Aluminum Alloy Casting	Magnesium Alloy Casting	Zinc Alloy Casting
	C ~0.25%	C0.25% ~0.45%	C 0.45%~	SCM	25 ~ 45 HRC	45 ~ 55 HRC	50 ~ 60 HRC	SUS	SKD	SC	FC	FCD	Cu	Bs	BsC	Ti	PB	AL	AC,ADC	MC	ZDC
V-TI-SFT																⊙					

DIN CRANKSHAFT

VPO-LW-SFT

Designed Specifically for Steel & Cast Iron shafts, Connecting Rods and Tie Rods.

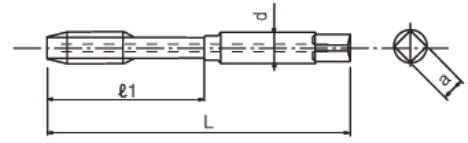

METRIC DIN 371 Oil Hole

Unit:mm

EDP NO.	Thread Size	TAP Limit	L	l1	d	a	Z	List Price (USD)
T1503078	M6x1	6HX	80	40	6	4.9	3	44.69
T1503079	M8x1.25	6HX	90	30	8	6.2	3	50.04
T1503080	M10x1.5	6HX	100	44	10	8	3	58.01

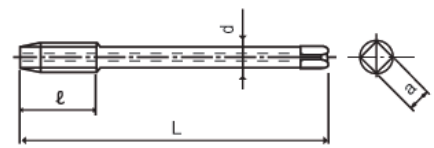

METRIC DIN 376 Oil Hole

Unit:mm

EDP NO.	Thread Size	TAP Limit	L	l	d	a	Z	List Price (USD)
T1506978	M12x1.75	6HX	110	18	9	7	3	70.70
T1503370	M14x2	6HX	110	20	11	9	3	76.37
T1503371	M16x2	6HX	110	20	12	9	3	90.36

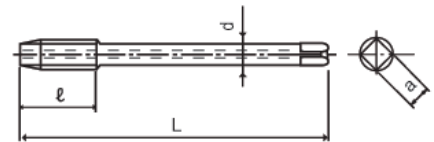

METRIC DIN 374 Oil Hole

Unit:mm

EDP NO.	Thread Size	TAP Limit	L	l	d	a	a	List Price (USD)
T1503372	M9x1	6HX	90	10	7	5.5	3	53.87
T1503373	M10x1	6HX	90	10	7	5.5	3	58.01
T1503374	M10x1.25	6HX	100	13	7	5.5	3	58.01
T1503413	M11x1.25	6HX	100	13	8	6.2	3	62.82
T1503375	M12x1.25	6HX	100	13	9	7	3	70.70
T1503376	M12x1.5	6HX	100	15	9	7	3	70.70
T1503377	M14x1.5	6HX	100	15	11	9	3	76.37
T1503378	M16x1.5	6HX	100	15	12	9	3	90.36

Abbreviation	Work Material				Hardened Steels			Stainless Steels	Tool Steels	Cast Steels	Cast Iron	Ductile Cast Iron	Copper	Brass	Brass Casting	Bronze	Aluminum Rolled	Aluminum Alloy Casting	Magnesium Alloy Casting	Zinc Alloy Casting
	Low Carbon Steels	Medium Carbon Steels	High Carbon Steels	Alloy Steels	25 ~ 45 HRC	45 ~ 55 HRC	50 ~ 60 HRC													
VPO-LW-SFT	C ~ 0.25%	C0.25% ~ 0.45%	C 0.45% ~	SCM				SUS	SKD	SC	FC	FCD	Cu	Bs	BsC	PB	AL	AC,ADC	MC	ZDC
		○	○	○							○	○		○	○	○		○		○

Designed specifically for through holes in connection rods and wheel hubs with tapping speed up to 40m/min.
This is also suitable for Firged Steel automotive components.

DIN AUTOMOBILE STEEL COMPONENT

WXL-CPM-RFT

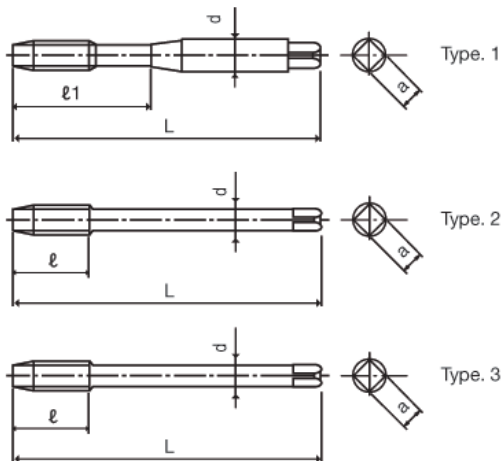

Unit:mm

METRIC DIN 371

EDP NO.	Thread Size	TAP Limit	L	l1	d	a	Z	Type	List Price (USD)
48043155	M6x1	6HX	80	30	6	4.9	3	1	45.72
48043158	M7x1	6HX	80	30	7	5.5	4	1	49.90
48043161	M8x1.25	6HX	90	35	8	6.2	4	1	49.90
48043165	M9x1.25	6HX	90	35	9	7	4	1	57.24
48043169	M10x1.5	6HX	100	39	10	8	4	1	57.24

Unit:mm

METRIC DIN 376

EDP NO.	Thread Size	TAP Limit	L	l	d	a	Z	Type	List Price (USD)
48013174	M11x1.5	6HX	100	24	8	6.2	5	2	47.25
48043179	M12x1.75	6HX	110	29	9	7	5	2	47.25
48043191	M14x2	6HX	110	30	11	9	5	2	81.09
48043202	M16x2	6HX	110	32	12	9	5	2	94.28
48043214	M18x2.5	6HX	125	34	14	11	5	2	121.69

Unit:mm

METRIC FINE DIN 374

EDP NO.	Thread Size	TAP Limit	L	l	d	a	Z	Type	List Price (USD)
48043162	M8x1	6HX	90	22	6	4.9	4	3	49.90
48043166	M9x1	6HX	90	22	7	5.5	5	3	57.24
48043171	M10x1	6HX	90	20	7	5.5	5	3	62.37
48043170	M10x1.25	6HX	100	24	7	5.5	5	3	59.89
48043175	M11x1.25	6HX	100	24	8	6.2	5	3	70.34
48043181	M12x1.25	6HX	100	22	9	7	5	3	47.25
48043180	M12x1.5	6HX	100	22	9	7	5	3	47.25
48043192	M14x1.5	6HX	100	22	11	9	5	3	81.09
48043203	M16x1.5	6HX	100	22	12	9	5	3	94.28
48043216	M18x1.5	6HX	110	25	14	11	5	3	121.69

Work Material Abbreviation	Low Carbon Steels			Medium Carbon Steels			High Carbon Steels			Alloy Steels			Hardened Steels			Stainless Steels	Tool Steels	Cast Steels	Cast Iron	Ductile Cast Iron	Copper	Brass	Brass Casting	Titanium	Bronze	Aluminum Rolled	Aluminum Alloy Casting	Magnesium Alloy Casting	Zinc Alloy Casting
	C	C0.25%	C0.45%	C	C0.25%	C0.45%	C	C0.25%	C0.45%	SCM	25 ~ 45 HRC	45 ~ 55 HRC	50 ~ 60 HRC	SUS	SKD	SC	FC	FCD	Cu	Bs	BsC	Ti	PB	AL	AC,ADC	MC	ZDC		
WXL-CPM-RFT		○	○	○	○	○	○	○	○	○	○	○	○	○	○	○	○	○	○	○	○	○	○	○	○	○	○	○	

DIN PETROCHEMICAL AND POWER INDUSTRY

Tapping for cast iron and steel

VXL-SFT

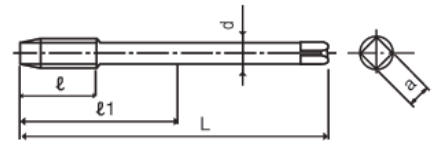

UNC/UN

Unit:mm

EDP NO.	Thread Size	TAP Limit	L	ℓ	ℓ1	d	a	Z	List Price (USD)
48051538	1-8 UNC	2B	160	25.4	90	18	14.5	5	234.72
48051552	1 1/8-8 UN	2B	180	25.4	100	22	18	5	330.75
48051565	1 1/4-8 UN	2B	180	25.4	100	22	18	5	400.09
48051578	1 3/8-8 UN	2B	200	25.4	115	28	22	5	448.12
48051592	1 1/2-8 UN	2B	200	25.4	115	32	24	5	576.18
48051618	1 3/4-4 UN	2B	200	25.4	101	36	29	6	1050.93
48051639	2-8 UN	2B	225	25.4	125	40	32	6	1493.73

DIN PETROCHEMICAL AND POWER INDUSTRY

Tapping for cast iron and steel

HXL-SFT

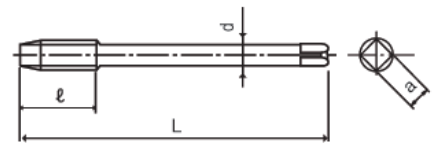

UNC/UN

Unit:mm

EDP NO.	Thread Size	TAP Limit	L	ℓ	ℓ1	d	a	Z	List Price (USD)
48050538	1-8 UNC	2B	160	25.4	90	18	14.5	5	234.72
48050552	1 1/8-8 UN	2B	180	25.4	100	22	18	5	330.75
48050565	1 1/4-8 UN	2B	180	25.4	100	22	18	5	400.09
48050578	1 3/8-8 UN	2B	200	25.4	115	28	22	5	448.12
48050592	1 1/2-8 UN	2B	200	25.4	115	32	24	5	576.18
48050618	1 3/4-4 UN	2B	200	25.4	101	36	29	5	1050.93
48050639	2-8 UN	2B	225	25.4	125	40	32	5	1493.73

Abbreviation	Work Material				Hardened Steels			Stainless Steels	Tool Steels	Cast Steels	Cast Iron	Ductile Cast Iron	Copper	Brass	Brass Casting	Bronze	Aluminum Rolled	Aluminum Alloy Casting	Magnesium Alloy Casting	Zinc Alloy Casting
	Low Carbon Steels	Medium Carbon Steels	High Carbon Steels	Alloy Steels	25 ~ 45 HRC	45 ~ 55 HRC	50 ~ 60 HRC													
	C ~ 0.25%	CO.25% ~ 0.45%	C 0.45% ~	SCM				SUS	SKD	SC	FC	FCD	Cu	Bs	BsC	PB	AL	AC,ADC	MC	ZDC
VXL-SFT	○	○	⊗	⊗	○			○	○	○										
HXL-SFT	○	○	⊗	⊗	○			○	○	○	⊗	⊗								

V-XPM-HT

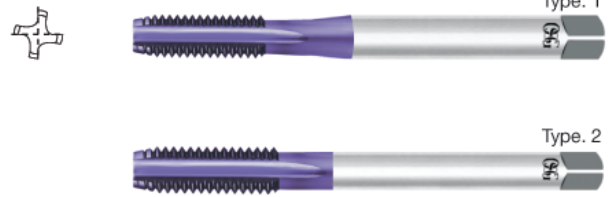
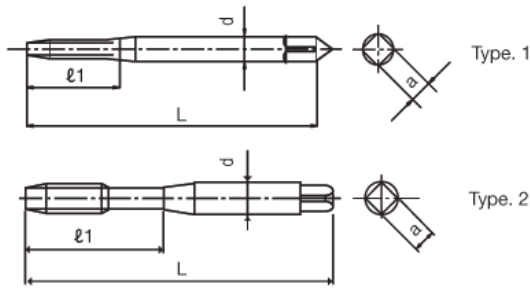

Unit:mm

METRIC DIN 371

EDP NO.	Thread Size	TAP Limit	L	l1	d	a	Z	Type	List Price (USD)
89913868	M3x0.5	6HX	46	19	3.5	2.7	4	1	56.70
89914468	M4x0.7	6HX	52	21	4.5	3.4	4	1	51.98
89914968	M5x0.8	6HX	60	24	6	4.9	4	1	53.41
89915568	M6x1.0	6HX	62	29	6	4.9	5	1	59.08
89916168	M8x1.25	6HX	70	22	6	4.9	5	2	68.99
89916968	M10x1.5	6HX	75	24	7	5.5	5	2	83.16

Unit:mm

METRIC DIN 376

EDP NO.	Thread Size	TAP Limit	L	l1	d	a	Z	Type	List Price (USD)
89917968	M12x1.75	6HX	82	29	9	7	5	2	110.11

Developed specially for automobile steel components such as crankshaft. Unique flute form to break chips into small pieces and oil hole enable high speed tapping.

VPO-MT

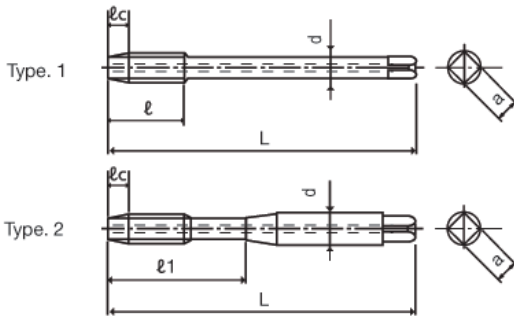

Unit:mm

Oil Hole METRIC DIN 371

EDP NO.	Thread Size	TAP Limit	lc	L	l1	d	a	Z	Type	List Price (USD)
T1102171	M6x1	6HX	2.5P	80	30	6	4.9	3	2	49.64
T1102176	M8x1.25	6HX	2.5P	90	35	8	6.2	4	2	55.58

Unit:mm

Oil Hole METRIC DIN 374

EDP NO.	Thread Size	TAP Limit	lc	L	l	d	a	Z	Type	List Price (USD)
T0803919	M10 x 1	6HX	5P	90	18	7	5.5	4	1	64.44
T0803920	M10 x 1.25	6HX	5P	100	18	7	5.5	4	1	64.44
T0803921	M12 x 1.25	6HX	2.5P	100	21	9	7	4	1	78.53
T0803922	M12 x 1.5	6HX	2.5P	100	21	9	7	4	1	78.53
T0803924	M14 x 1.5	6HX	2.5P	100	24	11	9	4	1	84.87
T0803926	M16 x 1.5	6HX	2.5P	100	24	12	9	4	1	100.4

Unit:mm

METRIC DIN 376

EDP NO.	Thread Size	TAP Limit	lc	L	l	d	a	Z	Type	List Price (USD)
T0803923	M14 x 2	6HX	5P	110	24	11	9	4	1	84.87
T0803925	M16 x 2	6HX	5P	110	24	12	9	4	1	100.40

Work Material Abbreviation	Low Carbon Steels		Medium Carbon Steels	High Carbon Steels	Alloy Steels	Hardened Steels			Stainless Steels	Tool Steels	Cast Steels	Cast Iron	Ductile Cast Iron	Copper	Brass	Brass Casting	Titanium	Bronze	Aluminum Rolled	Aluminum Alloy Casting	Magnesium Alloy Casting	Zinc Alloy Casting
	C ~0.25%	C0.25% ~0.45%	C 0.45% ~	SCM	25 ~ 45 HRC	45 ~ 55 HRC	50 ~ 60 HRC	SUS	SKD	SC	FC	FCD	Cu	Bs	BsC	Ti	PB	AL	AC,ADC	MC	ZDC	
V-XPM-HT																						
VPO-MT																						

TPT (NPT)

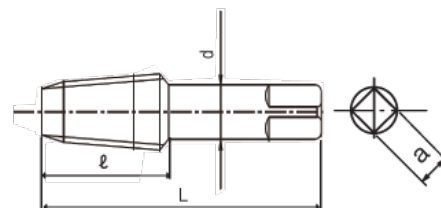
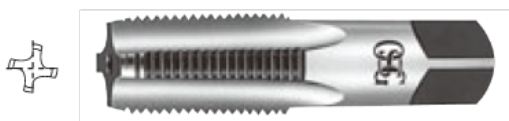

NPT DIN 2181

Unit:mm

EDP NO.	Thread Size	L	l	d	a	Z	List Price (USD)
60087500	1/16-27	56	14	6	4.9	4	49.06
60087600	1/8-27	63	15	7	5.5	4	64.94
60087700	1/4-18	63	21	11	9	4	74.39
60087800	3/8-18	70	21	12	9	4	88.61
60087900	1/2-14	80	27	16	12	4	106.03
60088000	3/4-14	100	27	20	16	5	212.68
60088100	1-11.5	100	32	25	20	5	268.2

Abbreviation	Work Material			Alloy Steels	Hardened Steels			Stainless Steels	Tool Steels	Cast Steels	Cast Iron	Ductile Cast Iron	Copper	Brass	Brass Casting	Bronze	Thermo Plastic	Aluminum Rolled	Aluminum Alloy Casting	Magnesium Alloy Casting	Zinc Alloy Casting
	Low Carbon Steels	Medium Carbon Steels	High Carbon Steels		25 ~ 45 HRC	45 ~ 55 HRC	50 ~ 60 HRC														
TPT (NPT)	○	○									○	○	○	○	○	○	○	○	○	○	○

Ideal for aluminum casting alloy and cast iron while using synchronized feed control machine due to rake angle 0 degree.

DIN ZERO TAP

V-DC-MT

HSS TAPS DIN

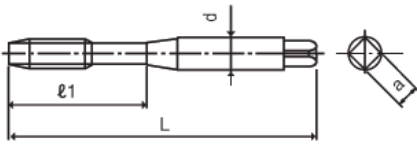

METRIC DIN 371

Unit:mm

EDP NO.	Thread Size	TAP Limit	L	l1	d	a	Z	List Price (USD)
48039149	M5 x 0.8	6HX	70	25	6	4.9	3	23.68
48039155	M6 x 1.0	6HX	80	30	6	4.9	3	23.85
48039161	M8 x 1.25	6HX	90	35	8	6.2	4	27.73
48039169	M10 x 1.5	6HX	100	39	10	8	4	32.32

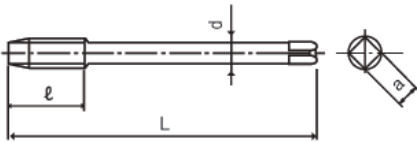

METRIC DIN 371

Unit:mm

EDP NO.	Thread Size	TAP Limit	L	l	d	a	Z	List Price (USD)
48039179	M12 x 1.75	6HX	110	21	9	7	4	48.69
48039191	M14 x 2	6HX	110	24	11	9	4	50.71
48039202	M16 x 2	6HX	110	24	12	9	4	60.30
48039214	M18 x 2.5	6HX	125	30	14	11	4	106.79
48039228	M20 x 2.5	6HX	140	30	16	12	4	122.63
48039238	M22 x 2.5	6HX	140	30	18	14.5	5	133.79
48039247	M24 x 3	6HX	160	36	18	14.5	5	164.70

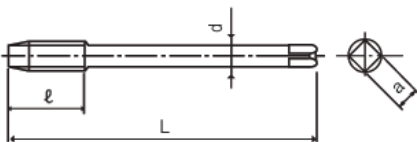

METRIC DIN 374

Unit:mm

EDP NO.	Thread Size	TAP Limit	L	l	d	a	Z	List Price (USD)
48039170	M10 x 1.25	6HX	100	18	7	5.5	4	35.56
48039181	M12 x 1.25	6HX	100	21	9	7	4	55.13
48039180	M12 x 1.5	6HX	100	21	9	7	4	46.71
48039192	M14 x 1.5	6HX	100	24	11	9	4	59.89
48039203	M16 x 1.5	6HX	100	24	12	9	4	70.02
48039216	M18 x 1.5	6HX	110	30	14	11	4	106.79
48039250	M24 x 1.5	6HX	140	24	18	14.5	5	164.70

Work Material	Low Carbon Steels			Medium Carbon Steels	High Carbon Steels	Alloy Steels	Hardened Steels			Stainless Steels	Tool Steels	Cast Steels	Cast Iron	Ductile Cast Iron	Copper	Brass	Brass Casting	Bronze	Aluminum Rolled	Aluminum Alloy Casting	Magnesium Alloy Casting	Zinc Alloy Casting
	C	CO.25%	C	C	SCM	25 ~ 45 HRC	45 ~ 55 HRC	50 ~ 60 HRC	SUS	SKD	SC	FC	FCD	Cu	Bs	BsC	PB	AL	AC,ADC	MC	ZDC	
V-DC-MT													○	○						○		

DIN ZERO TAP

V-DC-MT



Ideal for aluminum casting alloy and cast iron while using synchronized feed control machine due to rake angle 0 degree.

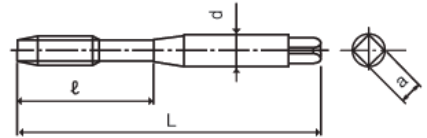

UNC DIN 2184-1

Unit:mm

EDP NO.	Thread Size	TAP Limit	L	ℓ1	d	a	Z	List Price (USD)
48039457	4-40 UNC	2B	56	18	3.5	2.7	3	38.53
48039459	5-40 UNC	2B	56	18	3.5	2.7	3	38.53
48039461	6-32 UNC	2B	56	20	4	3	3	36.54
48039464	8-32 UNC	2B	63	21	4.5	3.4	3	36.54
48039466	10-24 UNC	2B	70	25	6	4.9	3	38.53
48039471	1/4-20 UNC	2B	80	30	7	5.5	3	42.58
48039474	5/16-18 UNC	2B	90	35	8	6.2	4	44.60
48039479	3/8-16 UNC	2B	100	35	10	8	4	49.14

(Formerly was DIN 2182. No change of specifications)

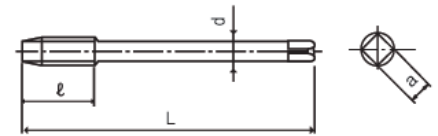

UNC DIN 2184-1

Unit:mm

EDP NO.	Thread Size	TAP Limit	L	ℓ	d	a	Z	List Price (USD)
48039484	7/16-14 UNC	2B	100	22	8	6.2	4	64.35
48039489	1/2-13 UNC	2B	110	24	9	7	4	66.91
48039494	9/16-12 UNC	2B	110	26	11	9	4	77.54
48039501	5/8-11 UNC	2B	110	28	12	9	4	88.16
48039515	3/4-10 UNC	2B	125	31	14	11	4	109.49
48039526	7/8-9 UNC	2B	140	34	18	14.5	5	138.83
48039538	1-8 UNC	2B	160	38	18	14.5	5	184.46

(Formerly was DIN 2183. No change of specifications)

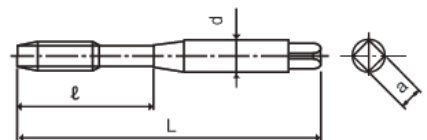

UNF DIN 2184-1

Unit:mm

EDP NO.	Thread Size	TAP Limit	L	ℓ1	d	a	Z	List Price (USD)
48039462	6-40 UNF	2B	56	18	4	3	3	43.07
48039467	10-32 UNF	2B	70	25	6	4.9	3	44.10
48039472	1/4-28 UNF	2B	80	30	7	5.5	3	50.14
48039476	5/16-24 UNF	2B	90	35	8	6.2	4	53.19
48039481	3/8-24 UNF	2B	90	35	9	7	4	54.22

(Formerly was DIN 2182. No change of specifications)

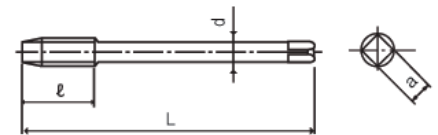

UNF DIN 2184-1

Unit:mm

EDP NO.	Thread Size	TAP Limit	L	ℓ	d	a	Z	List Price (USD)
48039486	7/16-20 UNF	2B	100	22	8	6.2	4	69.39
48039491	1/2-20 UNF	2B	100	24	9	7	4	68.40
48039496	9/16-18 UNF	2B	100	26	11	9	4	79.11
48039504	5/8-18 UNF	2B	100	28	12	9	4	89.73
48039517	3/4-16 UNF	2B	110	31	14	11	4	116.05
48039528	7/8-14 UNF	2B	125	23	18	14.5	5	142.92
48039539	1-12 UNF	2B	125	25	18	14.5	5	199.18

(Formerly was DIN 2183. No change of specifications)

Enables high speed tapping in aluminum casting alloy and cast iron due to oil hole that helps chip evacuation.

DIN ZERO TAP WITH OIL HOLE

OIL-V-DC-MT

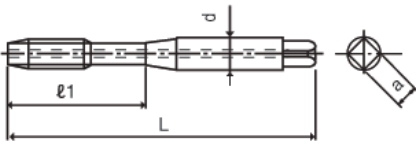

Oil Hole METRIC DIN 371

Unit:mm

EDP NO.	Thread Size	TAP Limit	L	l1	d	a	Z	List Price (USD)
48040149	M5 x 0.8	6HX	70	25	6	4.9	3	44.23
48040155	M6 x 1.0	6HX	80	30	6	4.9	3	44.55
48040161	M8 x 1.25	6HX	90	35	8	6.2	4	48.47
48040169	M10 x 1.5	6HX	100	39	10	8	4	50.71

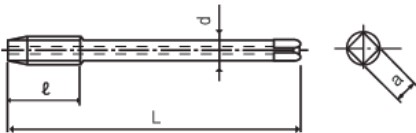

Oil Hole METRIC DIN 376

Unit:mm

EDP NO.	Thread Size	TAP Limit	L	l	d	a	Z	List Price (USD)
48040179	M12 x 1.75	6HX	110	21	9	7	4	67.01
48040191	M14 x 2	6HX	110	24	11	9	4	72.09
48040202	M16 x 2	6HX	110	24	12	9	4	81.63
48040214	M18 x 2.5	6HX	125	30	14	11	4	109.94

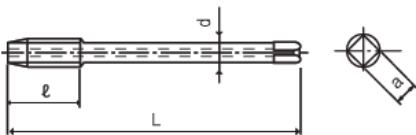

Oil Hole METRIC FINE DIN 374

Unit:mm

EDP NO.	Thread Size	TAP Limit	L	l	d	a	Z	List Price (USD)
48040170	M10 x 1.25	6HX	100	18	7	5.5	4	55.71
48040181	M12 x 1.25	6HX	100	21	9	7	4	68.23
48040180	M12 x 1.5	6HX	100	21	9	7	4	65.26
48040192	M14 x 1.5	6HX	100	24	11	9	4	81.36
48040203	M16 x 1.5	6HX	100	24	12	9	4	91.45
48040216	M18 x 1.5	6HX	110	30	14	11	4	109.94
48040240	M22 x 1.5	6HX	125	20	18	14.5	5	213.22
48040250	M24 x 1.5	6HX	140	24	18	14.5	5	232.79

Work Material Abbreviation	Low Carbon Steels			Medium Carbon Steels	High Carbon Steels	Alloy Steels	Hardened Steels			Stainless Steels	Tool Steels	Cast Steels	Cast Iron	Ductile Cast Iron	Copper	Brass	Brass Casting	Bronze	Aluminum Rolled	Aluminum Alloy Casting	Magnesium Alloy Casting	Zinc Alloy Casting
	C ~ 0.25%	CO.25% ~ 0.45%	C 0.45% ~			SCM	25 ~ 45 HRC	45 ~ 55 HRC	50 ~ 60 HRC	SUS	SKD	SC	FC	FCD	Cu	Bs	BsC	PB	AL	AC,ADC	MC	ZDC
OIL-V-DC-MT													○	○						○		

DIN ZERO TAP

V-DC-MT (FORM E)
(Formerly was V-SC-DC-MT)

Ideal for aluminum casting alloy and cast iron while using synchronized feed control machine due to rake angle 0 degree.

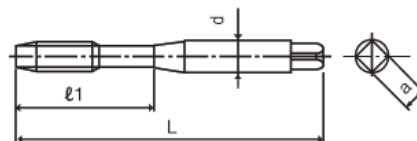

METRIC DIN 371

Unit:mm

EDP NO.	Thread Size	TAP Limit	L	l1	d	a	Z	List Price (USD)
48096155	M6 x 1	6HX	80	30	6	4.9	3	31.59
48096161	M8 x 1.25	6HX	90	35	8	6.2	4	36.67
48096169	M10 x 1.5	6HX	100	39	10	8	4	42.80

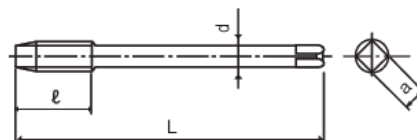

METRIC DIN 376

Unit:mm

EDP NO.	Thread Size	TAP Limit	L	l	d	a	Z	List Price (USD)
48096179	M12 x 1.75	6HX	110	21	9	7	4	64.31

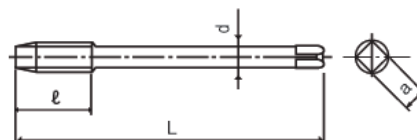

METRIC DIN 374

Unit:mm

EDP NO.	Thread Size	TAP Limit	L	l	d	a	Z	List Price (USD)
48096162	M8 x 1	6HX	90	15	6	4.9	4	36.67
48096170	M10 x 1.25	6HX	100	18	7	5.5	4	42.80
48096171	M10 x 1	6HX	90	18	7	5.5	4	42.80
48096180	M12 x 1.5	6HX	100	21	9	7	4	64.31
48096181	M12 x 1.25	6HX	100	21	9	7	4	64.31

Long tool life in Carbon and Alloy steels thanks to the high wear resistance and toughness of the Cobalt HSS substrate.



DIN S-XPf TAP

S-XPf

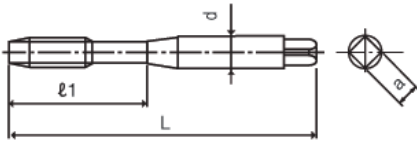

METRIC DIN 2174

Unit:mm

EDP NO.	Thread Size	TAP Limit	L	l1	d	a	Z	List Price (USD)
48030155	M6 x 1	6HX	80	30	6	4.9	5	41.85
48030161	M8 x 1.25	6HX	90	35	8	6.2	5	55.81
48030169	M10 x 1.5	6HX	100	39	10	8	8	72.31

(Formerly was DIN 371. No change of specifications)

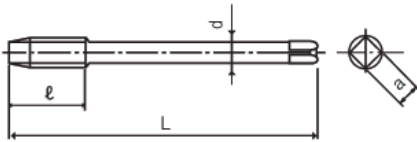

METRIC DIN 2174

Unit:mm

EDP NO.	Thread Size	TAP Limit	L	l	d	a	Z	List Price (USD)
48030179	M12 x 1.75	6HX	110	17	9	47	8	77.71
48030191	M14 x 2	6HX	110	20	11	9	8	103.95
48030202	M16 x 2	6HX	110	20	12	9	8	114.84

(Formerly was DIN 371. No change of specifications)

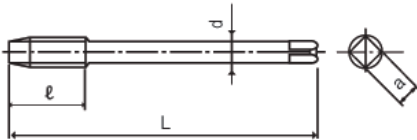

METRIC DIN 2174

Unit:mm

EDP NO.	Thread Size	TAP Limit	L	l	d	a	Z	List Price (USD)
48030162	M8 x 1	6HX	90	10	6	4.9	5	60.35
48030171	M10 x 1	6HX	90	12	7	5.5	8	72.31
48030170	M10 x 1.25	6HX	100	12	7	5.5	8	72.31
48030182	M12 x 1	6HX	100	15	9	7	8	77.71
48030181	M12 x 1.25	6HX	100	15	9	7	8	77.71
48030180	M12 x 1.5	6HX	100	15	9	7	8	77.71
48030192	M14 x 1.5	6HX	100	15	11	9	8	103.95
48030203	M16 x 1.5	6HX	100	15	12	9	8	168.84
48030216	M18 x 1.5	6HX	110	15	14	11	8	207.90
48030230	M20 x 1.5	6HX	125	15	16	12	8	218.62

(Formerly was DIN 374. No change of specifications)

Work Material Abbreviation	Low Carbon Steels			Medium Carbon Steels	High Carbon Steels	Alloy Steels	Hardened Steels			Stainless Steels	Tool Steels	Cast Steels	Cast Iron	Ductile Cast Iron	Copper	Brass	Brass Casting	Bronze	Aluminum Rolled	Aluminum Alloy Casting	Magnesium Alloy Casting	Zinc Alloy Casting
	C ~0.25%	CO.25% ~0.45%	C 0.45% ~	SCM	25 ~ 45 HRC	45 ~ 55 HRC	50 ~ 60 HRC	SUS	SKD	SC	FC	FCD	Cu	Bs	BsC	PB	AL	AC,ADC	MC	ZDC		
S-XPf	○	○	○	○	○			○		○				○	○	○			○	○		○

DIN ZERO TAP WITH OIL HOLE



Long tool life in Carbon and Alloy steels thanks to the high wear resistance and toughness of the Cobalt HSS substrate.

OIL-S-XPf

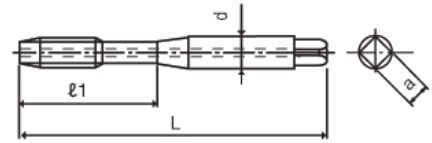

METRIC DIN 2174

Unit:mm

EDP NO.	Thread Size	TAP Limit	L	l1	d	a	Z	List Price (USD)
48042155	M6 x 1	6HX	80	30	6	4.9	5	79.06
48042161	M8 x 1.25	6HX	90	35	8	6.2	5	83.75
48042169	M10 x 1.5	6HX	100	39	10	8	8	91.48

(Formerly was DIN 371. No change of specifications)

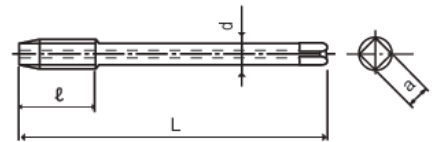

METRIC DIN 2174

Unit:mm

EDP NO.	Thread Size	TAP Limit	L	l	d	a	Z	List Price (USD)
48042179	M12 x 1.75	6HX	110	17	9	7	8	103.36
48042191	M14 x 2	6HX	110	20	11	9	8	121.96
48042202	M16 x 2	6HX	110	20	12	9	8	153.01
48071214	M18 x 2.5	6HX	125	20	14	11	8	166.01

(Formerly was DIN 376. No change of specifications)

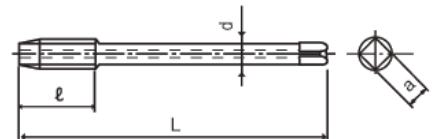

METRIC DIN 2174

Unit:mm

EDP NO.	Thread Size	TAP Limit	L	l	d	a	Z	List Price (USD)
48042162	M8 x 1	6HX	90	10	6	4.9	5	83.75
48042171	M10 x 1	6HX	90	12	7	5.5	8	101.84
48042170	M10 x 1.25	6HX	100	12	7	5.5	8	97.15
48042181	M12 x 1.25	6HX	100	15	9	7	8	103.36
48042180	M12 x 1.5	6HX	100	15	9	7	8	103.36
48042192	M14 x 1.5	6HX	100	15	11	9	8	121.96
48042203	M16 x 1.5	6HX	100	15	12	9	8	153.01
48042216	M18 x 1.5	6HX	110	20	14	11	8	168.48

(Formerly was DIN 374. No change of specifications)

Work Material Abbreviation	Low Carbon Steels			Medium Carbon Steels	High Carbon Steels	Alloy Steels	Hardened Steels			Stainless Steels	Tool Steels	Cast Steels	Cast Iron	Ductile Cast Iron	Copper	Brass	Brass Casting	Bronze	Aluminum Rolled	Aluminum Alloy Casting	Magnesium Alloy Casting	Zinc Alloy Casting
	C ~0.25%	CO.25% ~0.45%	C 0.45% ~	SCM	25 ~ 45 HRC	45 ~ 55 HRC	50 ~ 60 HRC	SUS	SKD	SC	FC	FCD	Cu	Bs	BsC	PB	AL	AC,ADC	MC	ZDC		
OIL-S-XPf	○	○	○	○	○			○		○				○	○	○			○	○		○

Long tool life in wide range of steel such as mild steel, alloy steel, carbon steel, and stainless steel as well as aluminum alloy.

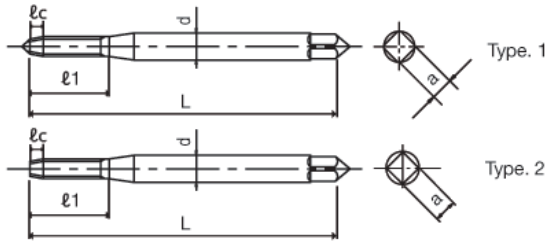

Unit:mm

EDP NO.	Thread Size	TAP Limit	ℓ_c	L	ℓ_1	d	a	Type	List Price (USD)
48121138	M3 x 0.5	RH5	4P	46	18	4	2.5	1	20.98
48122138	M3 x 0.5	RH5	2.5P	46	18	4	2.5	2	20.98
48123138	M3 x 0.5	RH6	4P	46	18	4	2.5	1	20.98
48124138	M3 x 0.5	RH6	2.5P	46	18	4	2.5	2	20.98
48121144	M4 x 0.7	RH6	4P	52	20	5	3.15	1	22.14
48122144	M4 x 0.7	RH6	2.5P	52	20	5	3.15	2	22.14
48123144	M4 x 0.7	RH7	4P	52	20	5	3.15	1	22.14
48124144	M4 x 0.7	RH7	2.5P	52	20	5	3.15	2	22.14
48121149	M5 x 0.8	RH6	4P	60	22	5.5	4	1	23.49
48122149	M5 x 0.8	RH6	2.5P	60	22	5.5	4	2	23.49
48123149	M5 x 0.8	RH8	4P	60	22	5.5	4	1	23.49
48124149	M5 x 0.8	RH8	2.5P	60	22	5.5	4	2	23.49
48121155	M6 x 1	RH7	4P	62	24	6	5	1	25.16
48122155	M6 x 1	RH7	2.5P	62	24	6	5	2	25.16
48123155	M6 x 1	RH9	4P	62	24	6	5	1	25.16
48124155	M6 x 1	RH9	2.5P	62	24	6	5	2	25.16

Unit:mm

EDP NO.	Thread Size	TAP Limit	ℓ_c	L	ℓ_1	d	a	Type	List Price (USD)
48116138	M3 x 0.5	6HX	2.5P	56	18	3.5	2.3	2	23.09
48118138	M3 x 0.5	6GX	2.5P	56	18	3.5	2.3	2	23.09
48116144	M4 x 0.7	6HX	2.5P	63	21	4.5	3.4	2	24.34
48118144	M4 x 0.7	6GX	2.5P	63	21	4.5	3.4	2	24.34
48116149	M5 x 0.8	6HX	2.5P	70	25	6	4.9	2	25.83
48118149	M5 x 0.8	6GX	2.5P	70	25	6	4.9	2	25.83
48116155	M6 x 1	6HX	2.5P	80	30	6	4.9	2	27.68
48118155	M6 x 1	6GX	2.5P	80	30	6	4.9	2	27.68

(Formerly was DIN 376. No change of specifications)

Enables High cutting Speed tapping in Aluminum, Stainless Steel & Steel due to Cobalt HSS substrate

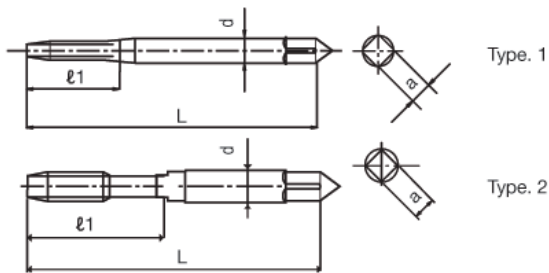

Unit:mm

EDP NO.	Thread Size	TAP Limit	L	ℓ_1	d	a	z	Type	List Price (USD)
48003111	M1x0.25	6HX	40	5.5	2.5	2.1	0	1	59.27
48003113	M1.2x0.25	6HX	40	5.5	2.5	2.1	0	1	57.06
66711568	M1.4x0.3	6HX	40	7	2.5	2.1	0	1	56.16
66711868	M1.6x0.35	6HX	40	8	2.5	2.1	0	1	55.08
66712568	M2x0.4	6HX	45	8	2.8	2.1	0	1	42.80
66712868	M2.2x0.45	6HX	45	9	2.8	2.1	0	1	45.68
66713368	M2.5x0.45	6HX	50	9	2.8	2.1	0	1	41.85
66713868	M3x0.5	6HX	56	18	3.5	2.7	2	2	40.32
66714068	M3.5x0.6	6HX	56	20	4	3	2	2	41.63
66714468	M4x0.7	6HX	63	21	4.5	3.4	2	2	40.82
66714968	M5x0.8	6HX	70	25	6	4.9	2	2	41.13

Abbreviation	Work Material			Alloy Steels	Hardened Steels			Stainless Steels	Tool Steels	Cast Steels	Cast Iron	Ductile Cast Iron	Copper	Brass	Brass Casting	Bronze	Aluminum Rolled	Aluminum Alloy Casting	Magnesium Alloy Casting	Zinc Alloy Casting
	Low Carbon Steels	Medium Carbon Steels	High Carbon Steels		25 ~ 45 HRC	45 ~ 55 HRC	50 ~ 60 HRC													
R-XPf	○	○	○	○				○		○				○	○	○		○	○	○
V-NRT-B	○	○	○	○				○						○	○	○		○	○	○

DIN R-XPf TAP

R-XPf



JIS FORM

DIN V NU-ROLL TAP

V-NRT-B



METRIC DIN 2174

SKS HAND TAP

NEW

General Application

HT

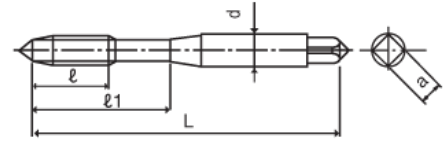

JIS METRIC

Unit:mm

EDP NO.	Thread Size	TAP Limit	L	ℓ	ℓ1	d	a	List Price (USD)
25013	M1x0.25	JIS 3	30	5.5		3	2.5	12.03
25014	M1x0.25 SET	JIS 3	30	5.5		3	2.5	36.08
25033	M1.2x0.25	JIS 3	32	5.5		3	2.5	11.31
25034	M1.2x0.25 SET	JIS 3	32	5.5		3	2.5	33.93
25053	M1.4x0.3	JIS 3	34	7		3	2.5	9.82
25054	M1.4x0.3 SET	JIS 3	34	7		3	2.5	29.45
25093	M1.7x0.35	JIS 3	36	8		3	2.5	7.54
25094	M1.7x0.35 SET	JIS 3	36	8		3	2.5	22.62
25123	M2x0.4	JIS 3	40	8		3	2.5	6.76
25124	M2x0.4 SET	JIS 3	40	8		3	2.5	20.28
25163	M2.3x0.4	JIS 3	42	9.5		3	2.5	8.26
25164	M2.3x0.4 SET	JIS 3	42	9.5		3	2.5	24.77
25193	M2.6x0.45	JIS 3	44	9.5		3	2.5	6.76
25194	M2.6x0.45 SET	JIS 3	44	9.5		3	2.5	20.28
25213	M3x0.5	JIS 3	46	11	19	4	3.2	4.49
25214	M3x0.5 SET	JIS 3	46	11	19	4	3.2	13.46
25263	M4x0.7	JIS 3	52	13	21	5	4	4.49
25264	M4x0.7 SET	JIS 3	52	13	21	5	4	13.46
25313	M5x0.8	JIS 3	60	16	24	5.5	4.5	5.27
25314	M5x0.8 SET	JIS 3	60	16	24	5.5	4.5	15.8
25343	M6x1.0	JIS 3	62	19	29	6	4.5	5.27
25344	M6x1.0 SET	JIS 3	62	19	29	6	4.5	15.8
25383	M8x1.25	JIS 3	70	22	37	6.2	5	8.26
25384	M8x1.25 SET	JIS 3	70	22	37	6.2	5	24.77
25413	M10x1.5	JIS 3	75	24	41	7	5.5	11.31
25414	M10x1.5 SET	JIS 3	75	24	41	7	5.5	33.93

~A set consists of 9P, 5P and 1.5P chamfer length.

Work Material Abbreviation	Low Carbon Steels	Medium Carbon Steels	High Carbon Steels	Alloy Steels	Hardened Steels			Stainless Steels	Tool Steels	Cast Steels	Cast Iron	Ductile Cast Iron	Copper	Brass	Brass Casting	Bronze	Aluminum Rolled	Aluminum Alloy Casting	Magnesium Alloy Casting	Zinc Alloy Casting
	C ~ 0.25%	C0.25% ~ 0.45%	C 0.45% ~	SCM	25 ~ 45 HRC	45 ~ 55 HRC	50 ~ 60 HRC	SUS	SKD	SC	FC	FCD	Cu	Bs	BsC	PB	AL	AC,ADC	MC	ZDC
HT (SKS)	○											○		○	○	○	○	○	○	○



GE S-XPF M-8
HSS-L TiCN 4800

CARBIDE DRILLS



Page	Abbreviation	Specification	Surface Treatment	Flute	Stocked Size
44-45	HYP-HP-GDS-3D	DRILL	WDI	2	1~20
46-47	HYP-HP-GDN-5D	DRILL	WDI	2	1~20
48-49	HYP-HPO-GDS-3D	DRILL(INTERNAL COOLANT)	WDI	2	3~20
50-51	HYP-HPO-GDN-5D	DRILL(INTERNAL COOLANT)	WDI	2	3~20
52	HYP-HPO-GDL-8D	DRILL(INTERNAL COOLANT)	WDI	2	3~12
54-55	HYP-MG-GDR	DRILL	-	2	0.7~12

CARBIDE DRILLS CONTENTS



**HY-PRO CARBIDE DRILL
3D HIGH PERFORMANCE TYPE**

HYP-HP-GDS-3D

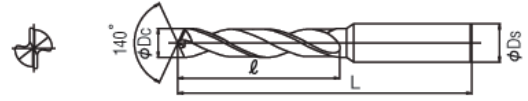

Unit:mm

Unit:mm

HY-PRO CARBIDE DRILLS

EDP NO.	Dc	l	L	Ds	List Price (USD)	
310301001	1	7	35	3	22.68	NEW
310301101	1.1	7	35	3	22.68	NEW
310301191	1.19(3/64)	7	35	3	22.68	NEW
310301201	1.2	8	35	3	22.68	NEW
310301301	1.3	8	35	3	22.68	NEW
310301401	1.4	9	35	3	22.68	NEW
310301501	1.5	9	40	3	22.68	NEW
310301591	1.59(1/16)	9	40	3	22.68	NEW
310301601	1.6	10	40	3	21.60	NEW
310301701	1.7	10	40	3	21.60	NEW
310301801	1.8	11	40	3	21.60	NEW
310301901	1.9	11	40	3	21.60	NEW
310301981	1.98(5/64)	11	40	3	21.60	NEW
310302001	2	13	45	3	21.60	NEW
310302101	2.1	13	45	3	21.24	NEW
310302201	2.2	13	45	3	21.24	NEW
310302301	2.3	13	45	3	21.24	NEW
310302381	2.38(3/32)	13	45	3	21.24	NEW
310302401	2.4	15	45	3	21.24	NEW
310302501	2.5	15	50	3	21.24	NEW
310302601	2.6	15	50	3	21.24	NEW
310302701	2.7	17	50	3	21.24	NEW
310302781	2.78(7/64)	17	50	3	21.24	NEW
310302801	2.8	17	50	3	21.24	NEW
310302901	2.9	17	50	3	21.24	NEW
310303001	3	20	62	6	31.21	
310303101	3.1	20	62	6	31.21	
310303171	3.18(1/8)	20	62	6	31.21	NEW
310303201	3.2	20	62	6	31.21	
310303301	3.3	20	62	6	31.21	
310303401	3.4	20	62	6	31.21	
310303501	3.5	20	62	6	31.21	
310303571	3.57(9/64)	20	62	6	31.21	NEW
310303601	3.6	20	62	6	31.21	
310303701	3.7	20	62	6	31.21	
310303801	3.8	24	66	6	31.21	
310303901	3.9	24	66	6	31.21	
310303971	3.97(5/32)	24	66	6	31.21	NEW
310304001	4	24	66	6	31.21	
310304101	4.1	24	66	6	31.21	
310304201	4.2	24	66	6	31.21	
310304301	4.3	24	66	6	31.21	

EDP NO.	Dc	l	L	Ds	List Price (USD)	
310304371	4.37(11/64)	24	66	6	31.21	NEW
310304401	4.4	24	66	6	31.21	
310304501	4.5	24	66	6	31.21	
310304601	4.6	24	66	6	31.21	
310304701	4.7	24	66	6	31.21	
310304761	4.76(3/16)	28	66	6	31.21	NEW
310304801	4.8	28	66	6	31.21	
310304901	4.9	28	66	6	31.21	
310305001	5	28	66	6	31.21	
310305101	5.1	28	66	6	31.21	
310305161	5.16(13/64)	28	66	6	31.21	NEW
310305201	5.2	28	66	6	31.21	
310305301	5.3	28	66	6	31.21	
310305401	5.4	28	66	6	31.21	
310305501	5.5	28	66	6	31.21	
310305561	5.56(7/32)	28	66	6	31.21	NEW
310305601	5.6	28	66	6	31.21	
310305701	5.7	28	66	6	31.21	
310305801	5.8	28	66	6	31.21	
310305901	5.9	28	66	6	31.21	
310305951	5.95(15/64)	28	66	6	31.21	NEW
310306001	6	28	66	6	31.21	
310306101	6.1	34	79	8	47.44	
310306201	6.2	34	79	8	47.44	
310306301	6.3	34	79	8	47.44	
310306351	6.35(1/4)	34	79	8	47.45	NEW
310306401	6.4	34	79	8	47.44	
310306501	6.5	34	79	8	47.44	
310306601	6.6	34	79	8	47.44	
310306701	6.7	34	79	8	47.44	
310306751	6.75(17/64)	34	79	8	47.45	NEW
310306801	6.8	34	79	8	47.44	
310306901	6.9	34	79	8	47.44	
310307001	7	34	79	8	47.44	
310307101	7.1	41	79	8	47.44	
310307141	7.14(9/32)	41	79	8	47.45	NEW
310307201	7.2	41	79	8	47.44	
310307301	7.3	41	79	8	47.44	
310307401	7.4	41	79	8	47.44	
310307501	7.5	41	79	8	47.44	
310307541	7.54(19/64)	41	79	8	47.45	NEW
310307601	7.6	41	79	8	47.44	

HY-PRO CARBIDE DRILL
3D HIGH PERFORMANCE TYPE



HYP-HP-GDS-3D

Unit:mm

EDP NO.	Dc	ℓ	L	Ds	List Price (USD)
310307701	7.7	41	79	8	47.44
310307801	7.8	41	79	8	47.44
310307901	7.9	41	79	8	47.44
310307941	7.94 (5/16)	41	79	8	47.45 NEW
310308001	8	41	79	8	47.44
310308101	8.1	47	89	10	66.56
310308201	8.2	47	89	10	66.56
310308301	8.3	47	89	10	66.56
310308331	8.33 (21/64)	47	89	10	66.56 NEW
310308401	8.4	47	89	10	66.56
310308501	8.5	47	89	10	66.56
310308601	8.6	47	89	10	66.56
310308701	8.7	47	89	10	66.56
310308731	8.73 (11/32)	47	89	10	66.56 NEW
310308801	8.8	47	89	10	66.56
310308901	8.9	47	89	10	66.56
310309001	9	47	89	10	66.56
310309101	9.1	47	89	10	66.56
310309131	9.13 (23/64)	47	89	10	66.56 NEW
310309201	9.2	47	89	10	66.56
310309301	9.3	47	89	10	66.56
310309401	9.4	47	89	10	66.56
310309501	9.5	47	89	10	66.56
310309521	9.52 (3/8)	47	89	10	66.56 NEW
310309601	9.6	47	89	10	66.56
310309701	9.7	47	89	10	66.56
310309801	9.8	47	89	10	66.56
310309901	9.9	47	89	10	66.56
310309921	9.92 (25/64)	47	89	10	66.56 NEW
310310001	10	47	89	10	66.56
310310101	10.1	55	102	12	84.16
310310201	10.2	55	102	12	84.16
310310301	10.3	55	102	12	84.16
310310321	10.32 (13/32)	55	102	12	84.17 NEW
310310401	10.4	55	102	12	84.16
310310501	10.5	55	102	12	84.16
310310601	10.6	55	102	12	84.16
310310701	10.7	55	102	12	84.16
310310721	10.72 (27/64)	55	102	12	84.17 NEW
310310801	10.8	55	102	12	84.16
310310901	10.9	55	102	12	84.16
310311001	11	55	102	12	84.16

Unit:mm

EDP NO.	Dc	ℓ	L	Ds	List Price (USD)
310311101	11.1	55	102	12	84.16
310311111	11.11 (7/16)	55	102	12	84.17 NEW
310311201	11.2	55	102	12	84.16
310311301	11.3	55	102	12	84.16
310311401	11.4	55	102	12	84.16
310311501	11.5	55	102	12	84.16
310311511	11.51 (29/64)	55	102	12	84.17 NEW
310311601	11.6	55	102	12	84.16
310311701	11.7	55	102	12	84.16
310311801	11.8	55	102	12	84.16
310311901	11.9	55	102	12	84.16
310311911	11.91 (15/32)	55	102	12	84.17 NEW
310312001	12	55	102	12	84.16
310312101	12.1	60	107	14	123.88 NEW
310312201	12.2	60	107	14	123.88 NEW
310312301	12.30 (31/64)	60	107	14	123.88 NEW
310312501	12.5	60	107	14	123.88 NEW
310312701	12.70 (1/2)	60	107	14	123.88 NEW
310313001	13	60	107	14	123.88 NEW
310313501	13.5	60	107	14	123.88 NEW
310313801	13.8	60	107	14	123.88 NEW
310314001	14	60	107	14	123.88 NEW
310314291	14.29 (9/16)	65	115	16	159.95 NEW
310314501	14.5	65	115	16	159.95 NEW
310314801	14.8	65	115	16	159.95 NEW
310315001	15	65	115	16	159.95 NEW
310315501	15.5	65	115	16	159.95 NEW
310315801	15.8	65	115	16	159.95 NEW
310315871	15.87 (5/8)	65	115	16	159.95 NEW
310316001	16	65	115	16	159.95 NEW
310316501	16.5	73	123	18	253.51 NEW
310316801	16.8	73	123	18	253.51 NEW
310317001	17	73	123	18	253.51 NEW
310317501	17.5	73	123	18	253.51 NEW
310317801	17.8	73	123	18	253.51 NEW
310318001	18	73	123	18	253.51 NEW
310318501	18.5	79	131	20	302.44 NEW
310319001	19	79	131	20	302.44 NEW
310319051	19.05 (3/4)	79	131	20	302.44 NEW
310319501	19.5	79	131	20	302.44 NEW
310319801	19.8	79	131	20	302.44 NEW
310320001	20	79	131	20	302.44 NEW

HY-PRO CARBIDE DRILLS

Low Carbon Steels	Medium Carbon Steels	High Carbon Steels	Alloy Steels	Hardened Steels		Quenched and Tempered Steels			Stainless Steels	Tool Steels	Cast Iron	Ductile Cast Iron	Copper Alloys	Aluminum	Aluminum Alloy Casting	Titanium	Titanium Alloys	Inconel®	Magnesium Alloy	Metal Matrix Composites
C ~ 0.25%	C0.25 ~ 0.45%	C0.45% ~	SCM	~ 35 HRC	35 ~ 45 HRC	45 ~ 50 HRC	50 ~ 62 HRC	62 ~ 70 HRC	SUS	SKD SKS	FC	FCD	Cu	AL	AC	TI			AZ91D	
○	○	○	○	○	○	○			○	○	○	○	○	○	○				○	

HY-PRO CARBIDE DRILL
5D HIGH PERFORMANCE TYPE

HYP-HP-GDN-5D

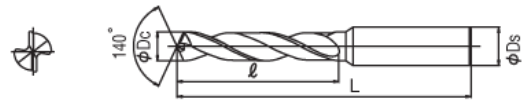

HY-PRO CARBIDE DRILLS



Unit:mm

Unit:mm

EDP NO.	Dc	l	L	Ds	List Price (USD)	
310501001	1	9	38	3	24.12	NEW
310501101	1.1	9	38	3	24.12	NEW
310501191	1.19 (3/64)	9	38	3	24.12	NEW
310501201	1.2	11	38	3	24.12	NEW
310501301	1.3	11	38	3	24.12	NEW
310501401	1.4	12	38	3	24.12	NEW
310501501	1.5	12	45	3	24.12	NEW
310501591	1.59 (1/16)	12	45	3	24.12	NEW
310501601	1.6	14	45	3	23.40	NEW
310501701	1.7	14	45	3	23.40	NEW
310501801	1.8	16	45	3	23.40	NEW
310501901	1.9	16	45	3	23.40	NEW
310501981	1.98 (5/64)	16	45	3	23.40	NEW
310502001	2	18	52	3	23.40	NEW
310502101	2.1	18	52	3	22.86	NEW
310502201	2.2	20	52	3	22.86	NEW
310502301	2.3	20	52	3	22.86	NEW
310502381	2.38 (3/32)	20	52	3	22.86	NEW
310502401	2.4	22	52	3	22.86	NEW
310502501	2.5	22	56	3	22.86	NEW
310502601	2.6	22	56	3	22.86	NEW
310502701	2.7	23	56	3	22.86	
310502781	2.78 (7/64)	23	56	3	22.86	NEW
310502801	2.8	23	56	3	22.86	
310502901	2.9	23	56	3	22.86	
310503001	3	28	66	6	39.56	
310503101	3.1	28	66	6	39.56	
310503171	3.17 (1/8)	28	66	6	39.56	NEW
310503201	3.2	28	66	6	39.56	
310503301	3.3	28	66	6	39.56	
310503401	3.4	28	66	6	39.56	
310503501	3.5	28	66	6	39.56	
310503571	3.57 (9/64)	28	66	6	31.21	NEW
310503601	3.6	28	66	6	39.56	
310503701	3.7	28	66	6	39.56	
310503801	3.8	36	74	6	43.02	
310503901	3.9	36	74	6	43.02	
310503971	3.97 (5/32)	36	74	6	43.02	NEW
310504001	4	36	74	6	43.02	
310504101	4.1	36	74	6	43.02	
310504201	4.2	36	74	6	43.02	
310504301	4.3	36	74	6	43.02	

EDP NO.	Dc	l	L	Ds	List Price (USD)	
310504371	4.37 (11/64)	36	74	6	43.02	NEW
310504401	4.4	36	74	6	43.02	
310504501	4.5	36	74	6	43.02	
310504601	4.6	36	74	6	43.02	
310504701	4.7	36	74	6	43.02	
310504761	4.76 (3/16)	44	82	6	43.02	NEW
310504801	4.8	44	82	6	43.02	
310504901	4.9	44	82	6	43.02	
310505001	5	44	82	6	43.02	
310505101	5.1	44	82	6	43.02	
310505161	5.16 (13/64)	44	82	6	43.02	NEW
310505201	5.2	44	82	6	43.02	
310505301	5.3	44	82	6	43.02	
310505401	5.4	44	82	6	43.02	
310505501	5.5	44	82	6	43.02	
310505561	5.56 (7/32)	44	82	6	43.02	NEW
310505601	5.6	44	82	6	43.02	
310505701	5.7	44	82	6	43.02	
310505801	5.8	44	82	6	43.02	
310505901	5.9	44	82	6	43.02	
310505951	5.95 (15/64)	44	82	6	43.02	NEW
310506001	6	44	82	6	43.02	
310506101	6.1	53	91	8	61.38	
310506201	6.2	53	91	8	61.38	
310506301	6.3	53	91	8	61.38	
310506351	6.35 (1/4)	53	91	8	61.38	NEW
310506401	6.4	53	91	8	61.38	
310506501	6.5	53	91	8	61.38	
310506601	6.6	53	91	8	61.38	
310506701	6.7	53	91	8	61.38	
310506751	6.75 (17/64)	53	91	8	61.38	NEW
310506801	6.8	53	91	8	61.38	
310506901	6.9	53	91	8	61.38	
310507001	7	53	91	8	61.38	
310507101	7.1	53	91	8	61.38	
310507141	7.14 (9/32)	53	91	8	61.38	NEW
310507201	7.2	53	91	8	61.38	
310507301	7.3	53	91	8	61.38	
310507401	7.4	53	91	8	61.38	
310507501	7.5	53	91	8	61.38	
310507541	7.54 (19/64)	53	91	8	61.38	NEW
310507601	7.6	53	91	8	61.38	

HY-PRO CARBIDE DRILL
5D HIGH PERFORMANCE TYPE



HYP-HP-GDN-5D



Unit:mm

EDP NO.	Dc	ℓ	L	Ds	List Price (USD)
310507701	7.7	53	91	8	61.38
310507901	7.8	53	91	8	61.38
310507901	7.9	53	91	8	61.38
310507941	7.94 (5/16)	53	91	8	61.38 NEW
310508001	8	53	91	8	61.38
310508101	8.1	61	103	10	76.68
310508201	8.2	61	103	10	76.68
310508301	8.3	61	103	10	76.68
310508331	8.33 (21/64)	61	103	10	76.68 NEW
310508401	8.4	61	103	10	76.68
310508501	8.5	61	103	10	76.68
310508601	8.6	61	103	10	76.68
310508701	8.7	61	103	10	76.68
310508731	8.73 (11/32)	61	103	10	76.68 NEW
310508801	8.8	61	103	10	76.68
310508901	8.9	61	103	10	76.68
310509001	9	61	103	10	76.68
310509101	9.1	61	103	10	76.68
310509131	9.13 (23/64)	61	103	10	76.68 NEW
310509201	9.2	61	103	10	76.68
310509301	9.3	61	103	10	76.68
310509401	9.4	61	103	10	76.68
310509501	9.5	61	103	10	76.68
310509521	9.52 (3/8)	61	103	10	76.68 NEW
310509601	9.6	61	103	10	76.68
310509701	9.7	61	103	10	76.68
310509801	9.8	61	103	10	76.68
310509901	9.9	61	103	10	76.68
310509921	9.92 (25/64)	61	103	10	76.68 NEW
310510001	10	61	103	10	76.68
310510101	10.1	71	118	12	127.33
310510201	10.2	71	118	12	127.33
310510301	10.3	71	118	12	127.33
310510321	10.32 (13/32)	71	118	12	127.33 NEW
310510401	10.4	71	118	12	127.33
310510501	10.5	71	118	12	127.33
310510601	10.6	71	118	12	127.33
310510701	10.7	71	118	12	127.33
310510721	10.72 (27/64)	71	118	12	127.33 NEW
310510801	10.8	71	118	12	127.33
310510901	10.9	71	118	12	127.33
310511001	11	71	118	12	127.33

Unit:mm

EDP NO.	Dc	ℓ	L	Ds	List Price (USD)
310511101	11.1	71	118	12	127.33
310511111	11.11 (7/16)	71	118	12	127.33 NEW
310511201	11.2	71	118	12	127.33
310511301	11.3	71	118	12	127.33
310511401	11.4	71	118	12	127.33
310511501	11.5	71	118	12	127.33
310511511	11.51 (29/64)	71	118	12	127.33 NEW
310511601	11.6	71	118	12	127.33
310511701	11.7	71	118	12	127.33
310511801	11.8	71	118	12	127.33
310511901	11.9	71	118	12	127.33
310511911	11.91 (15/32)	71	118	12	127.33 NEW
310512001	12	71	118	12	127.33
310512301	12.30 (31/64)	77	124	14	144.86 NEW
310512501	12.5	77	124	14	144.86 NEW
310512701	12.70 (1/2)	77	124	14	144.86 NEW
310512801	12.8	77	124	14	144.86 NEW
310513001	13	77	124	14	144.86 NEW
310513501	13.5	77	124	14	144.86 NEW
310513801	13.8	77	124	14	144.86 NEW
310514001	14	77	124	14	144.86 NEW
310514291	14.29 (9/16)	83	133	16	209.2 NEW
310514501	14.5	83	133	16	209.2 NEW
310514801	14.8	83	133	16	209.2 NEW
310515001	15	83	133	16	209.2 NEW
310515501	15.5	83	133	16	209.2 NEW
310515801	15.8	83	133	16	209.2 NEW
310515871	15.87 (5/8)	83	133	16	209.2 NEW
310516001	16	83	133	16	209.2 NEW
310516501	16.5	93	143	18	302.65 NEW
310516801	16.8	93	143	18	302.65 NEW
310517001	17	93	143	18	302.65 NEW
310517501	17.5	93	143	18	302.65 NEW
310517801	17.8	93	143	18	302.65 NEW
310518001	18	93	143	18	302.65 NEW
310518501	18.5	101	153	20	360.76 NEW
310519001	19	101	153	20	360.76 NEW
310519051	19.05 (3/4)	101	153	20	360.76 NEW
310519501	19.5	101	153	20	360.76 NEW
310519801	19.8	101	153	20	360.76 NEW
310520001	20	101	153	20	360.76 NEW

HY-PRO CARBIDE DRILLS

Low Carbon Steels	Medium Carbon Steels	High Carbon Steels	Alloy Steels	Hardened Steels		Quenched and Tempered Steels			Stainless Steels	Tool Steels	Cast Iron	Ductile Cast Iron	Copper Alloys	Aluminum	Aluminum Alloy Casting	Titanium	Titanium Alloys	Inconel®	Magnesium Alloy	Metal Matrix Composites
C ~ 0.25%	C0.25 ~ 0.45%	C0.45% ~	SCM	~ 35 HRC	35 ~ 45 HRC	45 ~ 50 HRC	50 ~ 62 HRC	62 ~ 70 HRC	SUS	SKD SKS	FC	FCD	Cu	AL	AC	TI			AZ91D	
○	○	○	○	○	○	○	○		○	○	○	○	○	○	○	○	○		○	

**HY-PRO CARBIDE DRILL
3D HIGH PERFORMANCE TYPE WITH INTERNAL COOLANT**

HYP-HPO-GDS-3D



HY-PRO CARBIDE DRILLS



Unit:mm

Unit:mm

EDP NO.	Dc	ℓ	L	Ds	List Price (USD)
311303001	3	20	62	6	44.42
311303101	3.1	20	62	6	44.42
311303171	3.17 (1/8)	20	62	6	44.42 NEW
311303181	3.18 (1/8)	20	62	6	44.42 NEW
311303201	3.2	20	62	6	44.42
311303301	3.3	20	62	6	44.42
311303401	3.4	20	62	6	44.42
311303501	3.5	20	62	6	44.42
311303571	3.57 (9/64)	20	62	6	44.42 NEW
311303601	3.6	20	62	6	44.42
311303701	3.7	20	62	6	44.42
311303801	3.8	24	66	6	44.42
311303901	3.9	24	66	6	44.42
311303971	3.97 (5/32)	24	66	6	44.42 NEW
311304001	4	24	66	6	44.42
311304101	4.1	24	66	6	44.42
311304201	4.2	24	66	6	44.42
311304301	4.3	24	66	6	44.42
311304401	4.4	24	66	6	44.42
311304371	4.37 (11/64)	24	66	6	44.42 NEW
311304501	4.5	24	66	6	44.42
311304601	4.6	24	66	6	44.42
311304651	4.65	24	66	6	44.42
311304701	4.7	24	66	6	44.42
311304761	4.76 (3/16)	24	66	6	44.42 NEW
311304801	4.8	28	66	6	44.42
311304901	4.9	28	66	6	44.42
311305001	5	28	66	6	44.42
311305101	5.1	28	66	6	44.42
311305161	5.16 (13/64)	28	66	6	44.42 NEW
311305201	5.2	28	66	6	44.42
311305301	5.3	28	66	6	44.42
311305401	5.4	28	66	6	44.42
311305501	5.5	28	66	6	44.42
311305561	5.56 (7/32)	28	66	6	44.42 NEW
311305601	5.6	28	66	6	44.42
311305701	5.7	28	66	6	44.42
311305801	5.8	28	66	6	44.42
311305901	5.9	28	66	6	44.42
311305951	5.95 (15/64)	28	66	6	44.42 NEW
311306001	6	28	66	6	44.42
311306101	6.1	34	79	8	62.1

EDP NO.	Dc	ℓ	L	Ds	List Price (USD)
311306201	6.2	34	79	8	62.10
311306301	6.3	34	79	8	62.10
311306351	6.35 (1/4)	34	79	8	62.10 NEW
311306401	6.4	34	79	8	62.10
311306501	6.5	34	79	8	62.10
311306601	6.6	34	79	8	62.10
311306701	6.7	34	79	8	62.10
311306751	6.75 (17/64)	34	79	8	62.10 NEW
311306801	6.8	34	79	8	62.10
311306901	6.9	34	79	8	62.10
311307001	7	34	79	8	62.10
311307101	7.1	41	79	8	67.72
311307141	7.14 (9/32)	41	79	8	67.72 NEW
311307201	7.2	41	79	8	67.72
311307301	7.3	41	79	8	67.72
311307401	7.4	41	79	8	67.72
311307501	7.5	41	79	8	67.72
311307541	7.54 (19/64)	41	79	8	67.72 NEW
311307601	7.6	41	79	8	67.72
311307701	7.7	41	79	8	67.72
311307801	7.8	41	79	8	67.72
311307901	7.9	41	79	8	67.72
311307941	7.94 (5/16)	41	79	8	67.72 NEW
311308001	8	41	79	8	67.72
311308101	8.1	47	89	10	89.82
311308201	8.2	47	89	10	89.82
311308301	8.3	47	89	10	89.82
311308331	8.33 (21/64)	47	89	10	89.82 NEW
311308401	8.4	47	89	10	89.82
311308501	8.5	47	89	10	89.82
311308601	8.6	47	89	10	89.82
311308701	8.7	47	89	10	89.82
311308731	8.73 (11/32)	47	89	10	89.82 NEW
311308801	8.8	47	89	10	89.82
311308901	8.9	47	89	10	89.82
311309001	9	47	89	10	89.82
311309101	9.1	47	89	10	93.42
311309131	9.13 (23/64)	47	89	10	93.42 NEW
311309201	9.2	47	89	10	93.42
311309301	9.3	47	89	10	93.42
311309401	9.4	47	89	10	93.42
311309501	9.5	47	89	10	93.42

HY-PRO CARBIDE DRILL
3D HIGH PERFORMANCE TYPE WITH INTERNAL COOLANT



HYP-HPO-GDS-3D

Unit:mm

EDP NO.	Dc	ℓ	L	Ds	List Price (USD)
311309521	9.52(3/8)	47	89	10	93.42 NEW
311309601	9.6	47	89	10	93.42
311309701	9.7	47	89	10	93.42
311309801	9.8	47	89	10	93.42
311309901	9.9	47	89	10	93.42
311309921	9.92(25/64)	47	89	10	93.42 NEW
311310001	10	47	89	10	93.42
311310101	10.1	55	102	12	132.33
311310201	10.2	55	102	12	132.33
311310301	10.3	55	102	12	132.33
311310321	10.32(13/32)	55	102	12	132.34 NEW
311310401	10.4	55	102	12	132.33
311310501	10.5	55	102	12	132.33
311310601	10.6	55	102	12	132.33
311310701	10.7	55	102	12	132.33
311310721	10.72(27/64)	55	102	12	132.34 NEW
311310801	10.8	55	102	12	132.33
311310901	10.9	55	102	12	132.33
311311001	11	55	102	12	132.33
311311101	11.1	55	102	12	134.97
311311111	11.11(7/16)	55	102	12	134.96 NEW
311311201	11.2	55	102	12	134.97
311311301	11.3	55	102	12	134.97
311311401	11.4	55	102	12	134.97
311311501	11.5	55	102	12	134.97
311311511	11.51(29/64)	55	102	12	134.96 NEW
311311601	11.6	55	102	12	134.97
311311701	11.7	55	102	12	134.97

Unit:mm

EDP NO.	Dc	ℓ	L	Ds	List Price (USD)
311311801	11.8	55	102	12	134.97
311311901	11.9	55	102	12	134.97
311311911	11.91(15/32)	55	102	12	134.96 NEW
311312001	12	55	102	12	134.97
311312301	12.30(31/64)	60	107	14	134.96 NEW
311312501	12.5	60	107	14	165.17 NEW
311312701	12.70(1/2)	60	107	14	165.17 NEW
311313001	13	60	107	14	167.15 NEW
311313501	13.5	60	107	14	169.92 NEW
311313701	13.7	60	107	14	169.92 NEW
311314001	14	60	107	14	169.92 NEW
311314291	14.29(9/16)	65	115	16	220.46 NEW
311314501	14.5	65	115	16	220.46 NEW
311314701	14.7	65	115	16	220.46 NEW
311315001	15		115	16	220.46 NEW
311315501	15.5	65	115	16	225.29 NEW
311315701	15.7	65	115	16	225.29 NEW
311315871	15.87(5/8)	65	115	16	225.29 NEW
311316001	16	65	115	16	225.29 NEW
311316501	16.5	73	123	18	288.54 NEW
311317001	17	73	123	18	326.88 NEW
311317501	17.5	73	123	18	326.88 NEW
311318001	18	73	123	18	326.88 NEW
311318501	18.5	79	131	20	362.59 NEW
311319001	19	79	131	20	362.59 NEW
311319051	19.05(3/4)	79	131	20	362.59 NEW
311319501	19.5	79	131	20	385.74 NEW
311320001	20	79	131	20	398.09 NEW

HY-PRO CARBIDE DRILLS

Low Carbon Steels	Medium Carbon Steels	High Carbon Steels	Alloy Steels	Hardened Steels		Quenched and Tempered Steels			Stainless Steels	Tool Steels	Cast Iron	Ductile Cast Iron	Copper Alloys	Aluminum	Aluminum Alloy Casting	Titanium	Titanium Alloys	Inconel®	Magnesium Alloy	Metal Matrix Composites
C ~ 0.25%	C0.25 - 0.45%	C0.45% ~	SCM	~ 35 HRC	35 ~ 45 HRC	45 ~ 50 HRC	50 ~ 62 HRC	62 ~ 70 HRC	SUS	SKD SKS	FC	FCD	Cu	AL	AC	TI			AZ91D	
○	○	○	○	○	○	○			○	○	○	○	○	○	○		○		○	

HY-PRO CARBIDE DRILL
5D HIGH PERFORMANCE TYPE WITH INTERNAL COOLANT

HYP-HPO-GDN-5D

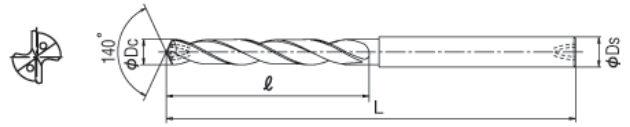

HY-PRO CARBIDE DRILLS



Unit:mm

EDP NO.	Dc	l	L	Ds	List Price (USD)
311503001	3	28	66	6	55.51
311503101	3.1	28	66	6	55.51
311503171	3.17 (1/8)	28	66	6	55.51 NEW
311503181	3.18 (1/8)	28	66	6	55.51 NEW
311503201	3.2	28	66	6	55.51
311503301	3.3	28	66	6	55.51
311503401	3.4	28	66	6	55.51
311503501	3.5	28	66	6	55.51
311503571	3.57 (9/64)	28	66	6	55.87 NEW
311503601	3.6	28	66	6	55.87
311503701	3.7	28	66	6	55.87
311503801	3.8	36	74	6	55.87
311503901	3.9	36	74	6	55.87
311503971	3.97 (5/32)	36	74	6	55.87 NEW
311504001	4	36	74	6	55.87
311504101	4.1	36	74	6	55.87
311504201	4.2	36	74	6	55.87
311504301	4.3	36	74	6	55.87
311504371	4.37 (11/64)	36	74	6	55.87 NEW
311504401	4.4	36	74	6	55.87
311504501	4.5	36	74	6	57.16
311504601	4.6	36	74	6	57.16
311504701	4.7	36	74	6	57.16
311504761	4.76 (3/16)	44	82	6	57.17 NEW
311504801	4.8	44	82	6	57.16
311504901	4.9	44	82	6	57.16
311505001	5	44	82	6	57.16
311505101	5.1	44	82	6	57.16
311505161	5.16 (13/64)	44	82	6	57.17 NEW
311505201	5.2	44	82	6	57.16
311505301	5.3	44	82	6	57.16
311505401	5.4	44	82	6	57.16
311505501	5.5	44	82	6	57.16
311505561	5.56 (7/32)	44	82	6	57.17 NEW
311505601	5.6	44	82	6	57.16
311505701	5.7	44	82	6	57.16
311505801	5.8	44	82	6	57.16
311505901	5.9	44	82	6	57.16
311505951	5.95 (15/64)	44	82	6	57.17 NEW
311506001	6	44	82	6	57.16
311506101	6.1	53	91	8	74.55
311506201	6.2	53	91	8	74.55

Unit:mm

EDP NO.	Dc	l	L	Ds	List Price (USD)
311506301	6.3	53	91	8	74.55
311506351	6.35 (1/4)	53	91	8	74.56 NEW
311506401	6.4	53	91	8	74.55
311506501	6.5	53	91	8	74.55
311506601	6.6	53	91	8	74.55
311506701	6.7	53	91	8	74.55
311506751	6.75 (17/64)	53	91	8	74.56 NEW
311506801	6.8	53	91	8	74.55
311506901	6.9	53	91	8	74.55
311507001	7	53	91	8	74.55
311507101	7.1	53	91	8	79.20
311507141	7.14 (9/32)	53	91	8	79.20 NEW
311507201	7.2	53	91	8	79.20
311507301	7.3	53	91	8	79.20
311507401	7.4	53	91	8	79.20
311507501	7.5	53	91	8	79.20
311507541	7.54 (19/64)	53	91	8	79.20 NEW
311507601	7.6	53	91	8	79.20
311507701	7.7	53	91	8	79.20
311507801	7.8	53	91	8	79.20
311507901	7.9	53	91	8	79.20
311507941	7.94 (5/16)	53	91	8	79.20 NEW
311508001	8	53	91	8	79.20
311508101	8.1	61	103	10	98.42
311508201	8.2	61	103	10	98.42
311508301	8.3	61	103	10	98.42
311508331	8.33 (21/64)	61	103	10	98.42 NEW
311508401	8.4	61	103	10	98.42
311508501	8.5	61	103	10	98.42
311508601	8.6	61	103	10	98.42
311508701	8.7	61	103	10	98.42
311508731	8.73 (11/32)	61	103	10	98.42 NEW
311508801	8.8	61	103	10	98.42
311508901	8.9	61	103	10	98.42
311509001	9	61	103	10	98.42
311509101	9.1	61	103	10	104.98
311509131	9.13 (23/64)	61	103	10	104.98 NEW
311509201	9.2	61	103	10	104.98
311509301	9.3	61	103	10	104.98
311509401	9.4	61	103	10	104.98
311509501	9.5	61	103	10	104.98
311509521	9.52 (3/8)	61	103	10	104.98 NEW

HY-PRO CARBIDE DRILL
5D HIGH PERFORMANCE TYPE WITH INTERNAL COOLANT



HYP-HPO-GDN-5D

Unit:mm

EDP NO.	Dc	ℓ	L	Ds	List Price (USD)
311509601	9.6	61	103	10	104.98
311509701	9.7	61	103	10	104.98
311509801	9.8	61	103	10	104.98
311509901	9.9	61	103	10	104.98
311509921	9.92 (25/64)	61	103	10	104.98
311510001	10	61	103	10	104.98
311510101	10.1	71	118	12	153.33
311510201	10.2	71	118	12	153.33
311510301	10.3	71	118	12	153.33
311510321	10.32 (13/32)	71	118	12	153.32
311510401	10.4	71	118	12	153.33
311510501	10.5	71	118	12	153.33
311510601	10.6	71	118	12	153.33
311510701	10.7	71	118	12	153.33
311510721	10.72 (27/64)	71	118	12	153.32
311510801	10.8	71	118	12	153.33
311510901	10.9	71	118	12	153.33
311511001	11	71	118	12	153.33
311511101	11.1	71	118	12	153.33
311511111	11.11 (7/16)	71	118	12	153.32
311511201	11.2	71	118	12	153.33
311511301	11.3	71	118	12	153.33
311511401	11.4	71	118	12	153.33
311511501	11.5	71	118	12	153.33
311511511	11.51 (29/64)	71	118	12	153.32

Unit:mm

EDP NO.	Dc	ℓ	L	Ds	List Price (USD)
311511601	11.6	71	118	12	153.33
311511701	11.7	71	118	12	153.33
311511801	11.8	71	118	12	153.33
311511901	11.9	71	118	12	153.33
311511911	11.91 (15/32)	71	118	12	153.32
311512001	12	71	118	12	153.33
311512301	12.30 (31/64)	77	124	14	199.87
311512501	12.5	77	124	14	199.87
311512701	12.70 (1/2)	77	124	14	199.87
311513001	13	77	124	14	199.87
311513501	13.5	77	124	14	202.90
311513701	13.7	77	124	14	202.90
311514001	14	77	124	14	202.90
311514501	14.5	83	133	16	202.90
311514701	14.7	83	133	16	251.64
311515001	15	83	133	16	251.64
311516001	16	83	133	16	261.04
311516501	16.5	93	143	18	261.04
311517001	17	93	143	18	324.76
311517501	17.5	93	143	18	355.79
311518001	18	93	143	18	386.17
311518501	18.5	101	153	20	420.16
311519001	19	101	153	20	425.92
311519501	19.5	101	153	20	461.27
311520001	20	101	153	20	461.27

HY-PRO CARBIDE DRILLS

Low Carbon Steels	Medium Carbon Steels	High Carbon Steels	Alloy Steels	Hardened Steels		Quenched and Tempered Steels			Stainless Steels	Tool Steels	Cast Iron	Ductile Cast Iron	Copper Alloys	Aluminum	Aluminum Alloy Casting	Titanium	Titanium Alloys	Inconel®	Magnesium Alloy	Metal Matrix Composites
C ~ 0.25%	C0.25 ~ 0.45%	C0.45% ~	SCM	~ 35 HRC	35 ~ 45 HRC	45 ~ 50 HRC	50 ~ 62 HRC	62 ~ 70 HRC	SUS	SKD SKS	FC	FCD	Cu	AL	AC	TI			AZ91D	
○	○	○	○	○	○	○			○	○	○	○	○	○	○		○		○	

HY-PRO CARBIDE DRILL
8D HIGH PERFORMANCE TYPE WITH INTERNAL COOLANT

HYP-HPO-GDL-8D

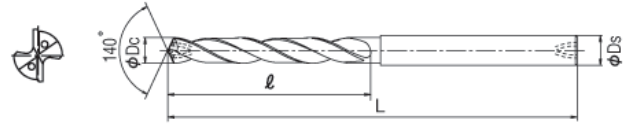

HY-PRO CARBIDE DRILLS



Unit:mm

EDP NO.	Dc	l	L	Ds	List Price (USD)
311803001	3	34	72	4	81.25
311803101	3.1	43	81	4	81.25
311803201	3.2	43	81	4	81.25
311803301	3.3	43	81	4	81.25
311803401	3.4	43	81	4	81.25
311803501	3.5	43	81	4	83.84
311803571	3.57	43	81	4	83.84
311803601	3.6	43	81	4	83.84
311803701	3.7	43	81	4	83.84
311803801	3.8	43	81	4	83.84
311803901	3.9	43	81	4	83.84
311804001	4	43	81	4	83.84
311804101	4.1	50	90	6	85.50
311804201	4.2	50	90	6	85.50
311804301	4.3	50	90	6	85.50
311804401	4.4	50	90	6	85.50
311804501	4.5	50	90	6	85.50
311804601	4.6	50	90	6	85.50
311804701	4.7	50	90	6	85.50
311804801	4.8	50	90	6	85.50
311804901	4.9	50	90	6	85.50
311805001	5	50	90	6	85.50
311805101	5.1	57	97	6	89.93
311805201	5.2	57	97	6	89.93
311805301	5.3	57	97	6	89.93
311805401	5.4	57	97	6	89.93
311805501	5.5	57	97	6	89.93
311805601	5.6	57	97	6	89.93
311805701	5.7	57	97	6	89.93
311805801	5.8	57	97	6	89.93
311805901	5.9	57	97	6	89.93
311806001	6	57	97	6	89.93
311806101	6.1	66	106	8	105.95
311806201	6.2	66	106	8	105.95
311806301	6.3	66	106	8	105.95
311806401	6.4	66	106	8	105.95
311806501	6.5	66	106	8	105.95
311806601	6.6	66	106	8	105.95
311806701	6.7	66	106	8	105.95
311806801	6.8	66	106	8	105.95
311806901	6.9	76	116	8	105.95
311807001	7	76	116	8	105.95
311807101	7.1	76	116	8	105.95
311807201	7.2	76	116	8	105.95
311807301	7.3	76	116	8	105.95
311807401	7.4	76	116	8	105.95
311807501	7.5	76	116	8	105.95

Unit:mm

EDP NO.	Dc	l	L	Ds	List Price (USD)
311807601	7.6	76	116	8	105.95
311807701	7.7	76	116	8	105.95
311807801	7.8	76	116	8	105.95
311807901	7.9	76	116	8	105.95
311808001	8	76	116	8	105.95
311808101	8.1	87	131	10	161.89
311808201	8.2	87	131	10	161.89
311808301	8.3	87	131	10	161.89
311808401	8.4	87	131	10	161.89
311808501	8.5	87	131	10	161.89
311808601	8.6	87	131	10	161.89
311808701	8.7	87	131	10	161.89
311808801	8.8	87	131	10	161.89
311808901	8.9	87	131	10	161.89
311809001	9	87	131	10	161.89
311809101	9.1	95	139	10	161.89
311809201	9.2	95	139	10	161.89
311809301	9.3	95	139	10	161.89
311809401	9.4	95	139	10	161.89
311809501	9.5	95	139	10	161.89
311809601	9.6	95	139	10	161.89
311809701	9.7	95	139	10	161.89
311809801	9.8	95	139	10	161.89
311809901	9.9	95	139	10	161.89
311810001	10	95	139	10	161.89
311810101	10.1	106	155	12	228.60
311810201	10.2	106	155	12	228.60
311810301	10.3	106	155	12	228.60
311810321	10.32	106	155	12	228.60
311810401	10.4	106	155	12	228.60
311810501	10.5	106	155	12	228.60
311810601	10.6	106	155	12	228.60
311810701	10.7	106	155	12	228.60
311810801	10.8	106	155	12	228.60
311810901	10.9	106	155	12	228.60
311811001	11	106	155	12	228.60
311811101	11.1	114	163	12	228.60
311811201	11.2	114	163	12	228.60
311811301	11.3	114	163	12	228.60
311811401	11.4	114	163	12	228.60
311811501	11.5	114	163	12	228.60
311811601	11.6	114	163	12	228.60
311811701	11.7	114	163	12	228.60
311811801	11.8	114	163	12	228.60
311811901	11.9	114	163	12	228.60
311812001	12	114	163	12	228.60

Low Carbon Steels	Medium Carbon Steels	High Carbon Steels	Alloy Steels	Hardened Steels					Quenched and Tempered Steels					Stainless Steels	Tool Steels	Cast Iron	Ductile Cast Iron	Copper Alloys	Aluminum	Aluminum Alloy Casting	Titanium	Titanium Alloys	Inconel®	Magnesium Alloy	Metal Matrix Composites
C ~ 0.25%	C0.25 - 0.45%	C0.45% ~	SCM	~ 35 HRC	35 ~ 45 HRC	45 ~ 50 HRC	50 ~ 62 HRC	62 ~ 70 HRC				SUS	SKD SKS	FC	FCD	Cu	AL	AC	TI					AZ91D	
○	○	○	○	○	○	○	○					○	○	○	○	○	○	○	○			○		○	



**HY-PRO CARBIDE DRILL
REGULAR LENGTH**

HYP-MG-GDR

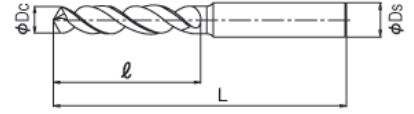

Unit:mm

Unit:mm

EDP NO.	Dc	l	L	Ds	List Price (USD)
202100700	0.7	6.5	30	0.7	8.39
202100800	0.8	8.5	30	0.8	8.39
202100900	0.9	9.5	30	0.9	8.39
202101000	1	11	30	1	8.39
202101100	1.1	11	30	1.1	8.39
202101200	1.2	13	30	1.2	8.39
202101300	1.3	13	30	1.3	8.39
202101400	1.4	13	30	1.4	8.39
202101500	1.5	13	30	1.5	8.39
202101600	1.6	17.5	40	1.6	8.39
202101700	1.7	17.5	40	1.7	8.39
202101800	1.8	17.5	40	1.8	8.39
202101900	1.9	17.5	40	1.9	8.39
202102000	2	17.5	40	2	8.39
202102100	2.1	17.5	40	2.1	9.50
202102200	2.2	17.5	40	2.2	9.50
202102300	2.3	17.5	40	2.3	9.50
202102400	2.4	17.5	40	2.4	9.50
202102500	2.5	17.5	40	2.5	9.50
202102600	2.6	20	45	2.6	10.66
202102700	2.7	20	45	2.7	10.66
202102800	2.8	20	45	2.8	10.66
202102900	2.9	20	45	2.9	10.66
202203000	3	33	61	3	10.66
202203100	3.1	36	65	3.1	12.60
202203200	3.2	36	65	3.2	12.60
202203300	3.3	36	65	3.3	12.60
202203400	3.4	39	70	3.4	12.60
202203500	3.5	39	70	3.5	12.60
202203600	3.6	39	70	3.6	14.26
202203700	3.7	39	70	3.7	14.26
202203800	3.8	43	75	3.8	14.26
202203900	3.9	43	75	3.9	14.26
202204000	4	43	75	4	14.26
202204100	4.1	43	75	4.1	16.85
202204200	4.2	43	75	4.2	16.85
202204300	4.3	47	80	4.3	16.85
202204400	4.4	47	80	4.4	16.85
202204500	4.5	47	80	4.5	16.85
202204600	4.6	47	80	4.6	18.28
202204700	4.7	47	80	4.7	18.28
202204800	4.8	52	86	4.8	18.28
202204900	4.9	52	86	4.9	18.28

EDP NO.	Dc	l	L	Ds	List Price (USD)
202205000	5	52	86	5	18.28
202205100	5.1	52	86	5.1	20.74
202205200	5.2	52	86	5.2	20.74
202205300	5.3	52	86	5.3	20.74
202205400	5.4	57	93	5.4	20.74
202205500	5.5	57	93	5.5	20.74
202205600	5.6	57	93	5.6	23.44
202205700	5.7	57	93	5.7	23.44
202205800	5.8	57	93	5.8	23.44
202205900	5.9	57	93	5.9	23.44
202206000	6	57	93	6	23.44
202206100	6.1	63	101	6.1	26.17
202206200	6.2	63	101	6.2	26.17
202206300	6.3	63	101	6.3	26.17
202206400	6.4	63	101	6.4	26.17
202206500	6.5	63	101	6.5	26.17
202206600	6.6	63	101	6.6	30.64
202206700	6.7	63	101	6.7	30.64
202206800	6.8	69	109	6.8	30.64
202206900	6.9	69	109	6.9	30.64
202207000	7	69	109	7	30.64
202207100	7.1	69	109	7.1	33.62
202207200	7.2	69	109	7.2	33.62
202207300	7.3	69	109	7.3	33.62
202207400	7.4	69	109	7.4	33.62
202207500	7.5	69	109	7.5	33.62
202207600	7.6	75	117	7.6	38.02
202207700	7.7	75	117	7.7	38.02
202207800	7.8	75	117	7.8	38.02
202207900	7.9	75	117	7.9	38.02
202208000	8	75	117	8	38.02
202208100	8.1	75	117	8.1	41.69
202208200	8.2	75	117	8.2	41.69
202208300	8.3	75	117	8.3	41.69
202208400	8.4	75	117	8.4	41.69
202208500	8.5	75	117	8.5	41.69
202208600	8.6	81	125	8.6	48.24
202208700	8.7	81	125	8.7	48.24
202208800	8.8	81	125	8.8	48.24
202208900	8.9	81	125	8.9	48.24
202209000	9	81	125	9	48.24
202209100	9.1	81	125	9.1	54.32
202209200	9.2	81	125	9.2	54.32

HY-PRO CARBIDE DRILLS

HY-PRO CARBIDE DRILL
REGULAR LENGTH



HYP-MG-GDR

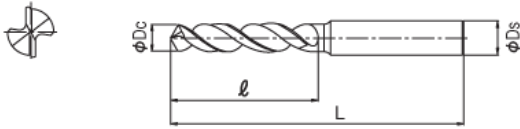

Unit:mm

EDP NO.	Dc	l	L	Ds	List Price (USD)
202209300	9.3	81	125	9.3	54.32
202209400	9.4	81	125	9.4	54.32
202209500	9.5	81	125	9.5	54.32
202209600	9.6	87	133	9.6	63.43
202209700	9.7	87	133	9.7	63.43
202209800	9.8	87	133	9.8	63.43
202209900	9.9	87	133	9.9	63.43
202210000	10	87	133	10	63.43
202210100	10.1	87	133	10.1	68.15
202210200	10.2	87	133	10.2	68.15
202210300	10.3	87	133	10.3	68.15
202210400	10.4	87	133	10.4	68.15
202210500	10.5	87	133	10.5	68.15
202210600	10.6	87	133	10.6	78.66

Unit:mm

EDP NO.	Dc	l	L	Ds	List Price (USD)
202210700	10.7	94	142	10.7	78.66
202210800	10.8	94	142	10.8	78.66
202210900	10.9	94	142	10.9	78.66
202211000	11	94	142	11	78.66
202211100	11.1	94	142	11.1	85.50
202211200	11.2	94	142	11.2	85.50
202211300	11.3	94	142	11.3	85.50
202211400	11.4	94	142	11.4	85.50
202211500	11.5	94	142	11.5	85.50
202211600	11.6	94	142	11.6	88.42
202211700	11.7	94	142	11.7	88.42
202211800	11.8	94	142	11.8	88.42
202211900	11.9	101	151	11.9	88.42
202212000	12	101	151	12	88.42

HY-PRO CARBIDE DRILLS

Low Carbon Steels	Medium Carbon Steels	High Carbon Steels	Alloy Steels	Hardened Steels		Quenched and Tempered Steels			Stainless Steels	Tool Steels	Cast Iron	Ductile Cast Iron	Copper Alloys	Aluminum	Aluminum Alloy Casting	Titanium	Titanium Alloys	Inconel®	Magnesium Alloy	Metal Matrix Composites
C ~ 0.25%	C0.25 - 0.45%	C0.45% ~	SCM	~ 35 HRC	35 ~ 45 HRC	45 ~ 50 HRC	50 ~ 62 HRC	62 ~ 70 HRC	SUS	SKD SKS	FC	FCD	Cu	AL	AC	TI			AZ91D	
○	○	○	○							○	⊗	○	○	⊗	⊗				⊗	

CARBIDE END MILLS



Page	Abbreviation	Specification	Surface Treatment	Flute	Stocked Size
58	TA-SMG-EDS	Square	WXL	2	1~20
	TA-SMG-EHS	Square	WXL	3	3~12
59	TA-SMG-EMS	Square	WXL	4	1~20
	TA-CMG-VMS NEW	Unequal Helix Square	WXL	4	1~25
60	TA-CMG-EMXL NEW	Square	WXL	4	3~25
	TA-CMG-RESF NEW	Square	WXL	4	3~25
61	SMG-EDS	Square	-	2	1~20
	SCA-ETS	Square	-	3	3~12
62	SMG-EMS	Square	-	4	1~20
63	TA-SMG-EBD	Ball Nose	WXL	2	1~20
	TA-CMG-EBD-S NEW	Ball Nose	WXS	2	1~20
64	TA-CMG-EBDL-S NEW	Ball Nose	WXS	2	1~12
	TA-CMG-EBM-S NEW	Ball Nose	WXS	4	3~12
	SMG-EBD	Ball Nose	-	2	1~20
65	GS-CR-EDS	Corner Radius	FX	2	1~16
66-67	GS-LN-CR-EDS	Long Neck Corner Radius	FX	2	0.8~12
68	AL+MG-ET	Square	-	3	1~20
69	AL+MG-ED	Square	-	2	1~20
	AL+MG-REE	Roughing	-	3	6~20

CARBIDE END MILLS CONTENTS



**HY-PRO CARBIDE END MILL
2 FLUTE SHORT WITH COATING**

TA-SMG-EDS

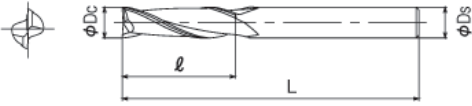

**HY-PRO CARBIDE END MILL
3 FLUTE HIGH HELIX SHORT WITH COATING**

TA-SMG-EHS

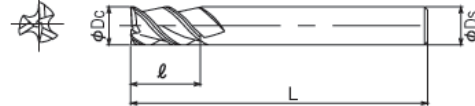

Unit:mm

EDP NO.	Ds	L	ℓ	Ds	List Price (USD)
S620010	1.0	40	2.5	4	14.53
S620015	1.5	40	4	4	13.73
S620020	2.0	40	6	4	13.73
S620025	2.5	40	8	4	13.73
S620030	3.0	45	8	6	13.73
S620035	3.5	45	10	6	17.09
S620040	4.0	45	11	6	17.09
S620045	4.5	45	11	6	18.55
S620050	5.0	50	13	6	18.55
S620060	6.0	50	13	6	23.13
S620070	7.0	60	16	8	35.51
S620080	8.0	60	19	8	38.20
S620090	9.0	70	19	10	54.31
S620100	10.0	70	22	10	54.31
S620110	11.0	75	22	12	62.83
S620120	12.0	75	26	12	73.00
S620140	14.0	85	26	16	133.11
S620160	16.0	100	32	16	134.83
S620180	18.0	100	32	18	178.65
S620200	20.0	105	38	20	223.32



Unit:mm

EDP NO.	Ds	L	ℓ	Ds	List Price (USD)
S650030	3.0	50	8	6	21.96
S650040	4.0	50	11	6	21.96
S650050	5.0	50	13	6	23.4
S650060	6.0	50	13	6	25.2
S650080	8.0	60	19	8	47.16
S650100	10.0	70	22	10	61.56
S650120	12.0	75	26	12	78.48

HY-PRO CARBIDE END MILLS

WORK MATERIAL	CARBON STEELS	PREHARDENED STEELS				STAINLESS STEELS	CAST IRON	COPPER ALLOYS	ALUMINUM ALLOYS	GRAPHITE	TITANIUM ALLOYS	HEAT RESISTANT ALLOYS	PLASTIC
	PREHARDENED STEELS ALLOY STEELS TOOL STEELS	HARDENED STEELS					DUCTILE CAST IRON						
Abbreviation	~ 40HRC	~ 45HRC	~ 55HRC	~ 60HRC	~ 65HRC	~ 35HRC	~ 350HB						
TA-SMG-EDS	⊙	⊙	⊙	○		○	⊙	○	○		○	○	
TA-SMG-EHS	⊙	⊙	⊙	○		○	⊙	○	○		○	○	

**HY-PRO CARBIDE END MILL
4 FLUTE SHORT WITH COATING**



TA-SMG-EMS

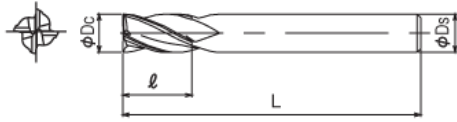

NEW

**HY-PRO CARBIDE ENDMILL
4 FLUTE UNEQUAL HELIX WITH COATING**



TA-CMG-VMS

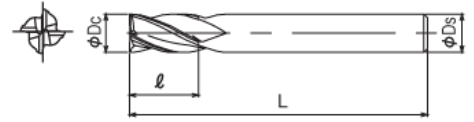

Unit:mm

EDP NO.	Dc	L	l	Ds	List Price (USD)
S640010	1.0	40	2.5	4	14.53
S640015	1.5	40	4	4	13.73
S640020	2.0	40	6	4	13.73
S640025	2.5	40	8	4	13.73
S640030	3.0	45	8	6	13.73
S640035	3.5	45	10	6	17.09
S640040	4.0	45	11	6	17.09
S640045	4.5	45	11	6	18.55
S640050	5.0	50	13	6	18.55
S640060	6.0	50	13	6	23.13
S640070	7.0	60	16	8	35.51
S640080	8.0	60	19	8	38.20
S640090	9.0	70	19	10	54.31
S640100	10.0	70	22	10	54.31
S640110	11.0	75	22	12	62.83
S640120	12.0	75	26	12	73.00
S640140	14.0	85	26	16	133.11
S640160	16.0	100	32	16	134.83
S640180	18.0	100	32	18	178.65
S640200	20.0	105	38	20	223.32



Unit:mm

EDP NO.	Dc	L	l	Ds	List Price (USD)
452039411	1	57	2.5	6	32.17
452078711	2	57	6	6	31.73
452118111	3	57	8	6	30.50
452157511	4	57	11	6	28.17
452196911	5	57	13	6	30.17
452236211	6	57	13	6	31.13
452315011	8	63	19	8	45.63
452393711	10	72	22	10	64.00
452472411	12	83	26	12	90.03
452551211	14	83	26	14	116.80
452629911	16	90	32	16	159.37
452787411	20	104	38	20	263.13
452984311	25	121	50	25	447.57

HY-PRO CARBIDE END MILLS

WORK MATERIAL	CARBON STEELS	PREHARDENED STEELS					STAINLESS STEELS	CAST IRON	COPPER ALLOYS	ALUMINUM ALLOYS	GRAPHITE	TITANIUM ALLOYS	HEAT RESISTANT ALLOYS	PLASTIC
	PREHARDENED STEELS ALLOY STEELS TOOL STEELS	HARDENED STEELS						DUCTILE CAST IRON						
Abbreviation	~ 40HRC	~ 45HRC	~ 55HRC	~ 60HRC	~ 65HRC	~ 35HRC	~ 350HB							
TA-SMG-EMS	○	○	○	○		○	○	○	○		○	○		
TA-CMG-VMS	○	○				○	○	○	○		○	○		

**HYPRO CARBIDE ENDMILL
4 FLUTE EXTRA LONG WITH COATING**

NEW

TA-CMG-EMXL

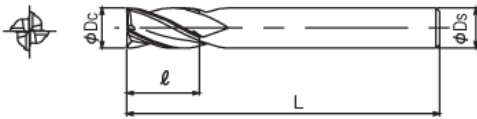

**HYPRO CARBIDE ENDMILL
4 FLUTE ROUGHING WITH COATING**

NEW

TA-CMG-RESF



Unit:mm

EDP NO.	Dc	L	l	Ds	List Price (USD)
484118111	3	76	25	3	23.73
484157511	4	76	28	4	28.20
484196811	5	76	32	5	30.47
484236211	6	102	38	6	37.30
484315011	8	102	42	8	60.70
484393711	10	102	45	10	79.83
484472411	12	153	76	12	143.73
484551211	14	153	76	14	198.83
484629911	16	153	76	16	235.57
484708711	18	153	76	18	318.07
484787411	20	153	76	20	361.70
484984311	25	153	76	25	539.20



Unit:mm

EDP NO.	Dia.	L	l	Ds	List Price (USD)
483118111	3	64	10	6	26.80
483157511	4	64	14	6	27.73
483196811	5	64	15	6	27.73
483236211	6	64	19	6	27.73
483315011	8	64	21	8	40.87
483393711	10	70	22	10	56.47
483472411	12	76	25	12	77.60
483629911	16	89	32	16	134.20
483787411	20	102	38	20	212.13
483984311	25	102	38	25	356.57

HY-PRO CARBIDE END MILLS

WORK MATERIAL	CARBON STEELS	PREHARDENED STEELS				STAINLESS STEELS	CAST IRON	COPPER ALLOYS	ALUMINUM ALLOYS	GRAPHITE	TITANIUM ALLOYS	HEAT RESISTANT ALLOYS	PLASTIC
	PREHARDENED STEELS ALLOY STEELS TOOL STEELS	HARDENED STEELS					DUCTILE CAST IRON						
Abbreviation	~ 40HRC	~ 45HRC	~ 55HRC	~ 60HRC	~ 65HRC	~ 35HRC	~ 350HB						
TA-CMG-EMXL	○	○	○	○		○	○	○	○		○	○	
TA-CMG-RESF	○	○				○	○	○	○		○	○	

**HY-PRO CARBIDE END MILL
2 FLUTE SHORT**



SMG-EDS



**HY-PRO CARBIDE END MILL
3 FLUTE SHORT**



SCA-ETS

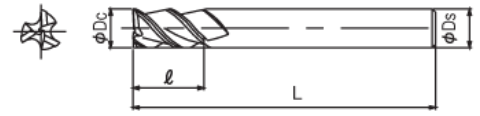

Unit:mm

EDP NO.	Dc	L	l	Ds	List Price (USD)
S520010	1.0	40	2.5	4	11.15
S520015	1.5	40	4	4	10.34
S520020	2.0	40	6	4	10.34
S520025	2.5	40	8	4	10.34
S520030	3.0	45	8	6	10.34
S520035	3.5	45	10	6	13.73
S520040	4.0	45	11	6	13.73
S520045	4.5	45	11	6	15.21
S520050	5.0	50	13	6	15.21
S520060	6.0	50	13	6	19.83
S520070	7.0	60	16	8	28.77
S520080	8.0	60	19	8	31.48
S520090	9.0	70	19	10	43.18
S520100	10.0	70	22	10	43.18
S520110	11.0	75	22	12	49.32
S520120	12.0	75	26	12	59.57
S520140	14.0	85	26	16	107.51
S520160	16.0	100	32	16	113.36
S520180	18.0	100	32	18	144.30
S520200	20.0	105	38	20	193.31



Unit:mm

EDP NO.	Dc	L	l	Ds	List Price (USD)
S530030	3.0	45	8	6	19.34
S530040	4.0	45	11	6	12.83
S530050	5.0	50	13	6	14.21
S530060	6.0	50	13	6	18.53
S530080	8.0	60	19	8	29.42
S530100	10.0	70	22	10	40.35
S530120	12.0	75	26	12	55.67

HY-PRO CARBIDE END MILLS

WORK MATERIAL	CARBON STEELS	PREHARDENED STEELS					STAINLESS STEELS	CAST IRON	COPPER ALLOYS	ALUMINUM ALLOYS	GRAPHITE	TITANIUM ALLOYS	HEAT RESISTANT ALLOYS	PLASTIC
	PREHARDENED STEELS ALLOY STEELS TOOL STEELS	HARDENED STEELS						DUCTILE CAST IRON						
Abbreviation	~ 40HRC	~ 45HRC	~ 55HRC	~ 60HRC	~ 65HRC	~ 35HRC	~ 350HB							
SMG-EDS	○						○	⊗	⊗				○	
SCA-ETS	○						○	⊗	⊗				○	

**HY-PRO CARBIDE END MILL
4 FLUTE SHORT**

SMG-EMS

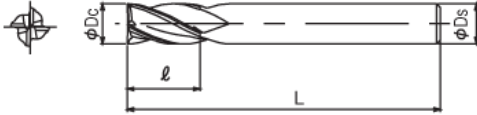

Unit:mm

EDP NO.	Dc	L	l	Ds	List Price (USD)
S540010	1.0	40	2.5	4	11.15
S540015	1.5	40	4	4	10.34
S540020	2.0	40	6	4	10.34
S540025	2.5	40	8	4	10.34
S540030	3.0	45	8	6	10.34
S540035	3.5	45	10	6	13.73
S540040	4.0	45	11	6	13.73
S540045	4.5	45	11	6	15.21
S540050	5.0	50	13	6	15.21
S540060	6.0	50	13	6	19.83
S540070	7.0	60	16	8	28.77
S540080	8.0	60	19	8	31.48
S540090	9.0	70	19	10	43.18
S540100	10.0	70	22	10	43.18
S540110	11.0	75	22	12	49.32
S540120	12.0	75	26	12	59.57
S540140	14.0	85	26	16	107.51
S540160	16.0	100	32	16	113.36
S540180	18.0	100	32	18	144.30
S540200	20.0	105	38	20	193.31

HY-PRO CARBIDE END MILLS

WORK MATERIAL	CARBON STEELS	PREHARDENED STEELS				STAINLESS STEELS	CAST IRON	COPPER ALLOYS	ALUMINUM ALLOYS	GRAPHITE	TITANIUM ALLOYS	HEAT RESISTANT ALLOYS	PLASTIC
	PREHARDENED STEELS ALLOY STEELS TOOL STEELS	HARDENED STEELS					DUCTILE CAST IRON						
Abbreviation	~ 40HRC	~ 45HRC	~ 55HRC	~ 60HRC	~ 65HRC	~ 35HRC	~ 350HB						
SMG-EMS	○						○	⊗	⊗				○

**HY-PRO CARBIDE END MILL
2 FLUTE BALL NOSE WITH COATING**



TA-SMG-EBD

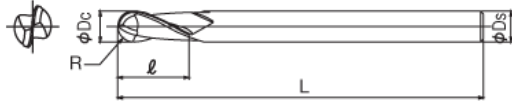

NEW

**HYPRO CARBIDE ENDMILL
2 FLUTE BALL NOSE WITH COATING**



TA-CMG-EBD-S

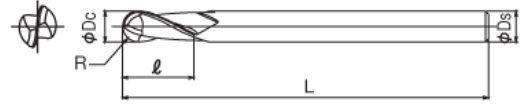

Unit:mm

EDP NO.	Dc	L	l	Ds	List Price (USD)
S610010	1.0	50	2.5	4	16.20
S610015	1.5	50	4	4	15.24
S610020	2.0	50	5	6	15.24
S610025	2.5	60	6	6	15.24
S610030	3.0	60	8	6	15.24
S610035	3.5	70	8	6	19.14
S610040	4.0	70	8	6	19.14
S610045	4.5	80	10	6	20.82
S610050	5.0	80	10	6	20.82
S610060	6.0	90	12	6	26.07
S610070	7.0	90	14	6	39.75
S610080	8.0	100	14	8	42.85
S610090	9.0	100	18	8	56.20
S610100	10.0	100	18	10	56.20
S610110	11.0	100	22	10	70.15
S610120	12.0	110	22	12	81.85
S610140	14.0	110	26	12	168.15
S610160	16.0	140	30	16	203.17
S610180	18.0	140	34	20	308.26
S610200	20.0	160	38	20	343.29



Unit:mm

EDP NO.	Dc	L	l	Ds	List Price (USD)
451201017	1	39	1.5	3	18.17
451202017	2	39	3	3	18.17
451203017	3	39	4.5	3	18.17
451204017	4	51	6	4	23.90
451205017	5	51	7.5	5	27.67
451206017	6	64	9	6	32.67
451208017	8	64	12	8	51.57
451210017	10	70	15	10	67.53
451212017	12	76	18	12	90.07
451216017	16	89	24	16	143.93
451220017	20	102	30	20	241.17

HY-PRO CARBIDE END MILLS

WORK MATERIAL	CARBON STEELS	PREHARDENED STEELS					STAINLESS STEELS	CAST IRON	COPPER ALLOYS	ALUMINUM ALLOYS	GRAPHITE	TITANIUM ALLOYS	HEAT RESISTANT ALLOYS	PLASTIC
	PREHARDENED STEELS ALLOY STEELS TOOL STEELS	HARDENED STEELS						DUCTILE CAST IRON						
Abbreviation	~ 40HRC	~ 45HRC	~ 55HRC	~ 60HRC	~ 65HRC	~ 35HRC	~ 350HB							
TA-SMG-EBD	○	○				○	○	○	○			○	○	
TA-CMG-EBD-S	○	○	○	○	○	○	○	○				○	○	

**HYPRO CARBIDE ENDMILL
2 FLUTE LONG BALLNOSE WITH COATING**

NEW

TA-CMG-EBDL-S

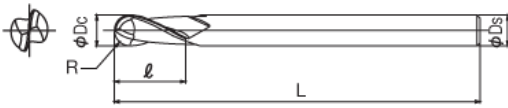

Unit:mm

EDP NO.	Dc	L	l	Ds	List Price (USD)
452201017	1	75	2.5	3	22.13
452202017	2	75	4	3	22.13
452203017	3	75	4.5	3	41.67
452204017	4	75	6	4	49.17
452205017	5	75	7.5	5	53.03
452206017	6	100	9	6	62.83
452208017	8	100	12	8	86.73
452210017	10	100	15	10	93.93
452212017	12	150	18	12	178.87

**HYPRO CARBIDE ENDMILL
4 FLUTE BALL NOSE WITH COATING**

NEW

TA-CMG-EBM-S

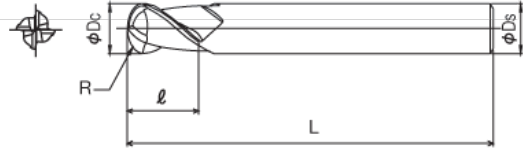

Unit:mm

EDP NO.	Dc	L	l	Ds	List Price (USD)
451403017	3	39	4.5	3	18.17
451404017	4	51	6	4	23.90
451406017	6	64	9	6	32.67
451408017	8	64	12	8	51.57
451410017	10	70	15	10	67.53
451412017	12	76	18	12	90.07

HY-PRO CARBIDE END MILLS

**HY-PRO CARBIDE END MILL
2 FLUTE BALL NOSE**

SMG-EBD

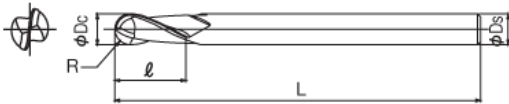

Unit:mm

EDP NO.	Dc	L	l	Ds	List Price (USD)
S510010	1.0	50	2.5	4	12.84
S510015	1.5	50	4	4	11.87
S510020	2.0	50	5	6	11.87
S510025	2.5	60	6	6	11.87
S510030	3.0	60	8	6	11.87
S510035	3.5	70	8	6	15.80
S510040	4.0	70	8	6	15.80
S510045	4.5	80	10	6	17.50
S510050	5.0	80	10	6	17.50
S510060	6.0	90	12	6	22.80
S510070	7.0	90	14	6	33.05
S510080	8.0	100	14	8	36.19
S510090	9.0	100	18	8	49.66
S510100	10.0	100	18	10	49.66
S510110	11.0	100	22	10	56.69
S510120	12.0	110	22	12	68.52
S510140	14.0	110	26	12	135.81
S510160	16.0	140	30	16	164.11
S510180	18.0	140	34	20	248.98
S510200	20.0	160	38	20	277.28

WORK MATERIAL	CARBON STEELS	PREHARDENED STEELS					STAINLESS STEELS	CAST IRON	COPPER ALLOYS	ALUMINUM ALLOYS	GRAPHITE	TITANIUM ALLOYS	HEAT RESISTANT ALLOYS	PLASTIC
	PREHARDENED STEELS ALLOY STEELS TOOL STEELS	HARDENED STEELS						DUCTILE CAST IRON						
Abbreviation	~ 40HRC	~ 45HRC	~ 55HRC	~ 60HRC	~ 65HRC	~ 35HRC	~ 350HB							
TA-CMG-EBDL-S	○	○	⊗	⊗	⊗	○	○	○				○	○	
TA-CMG-EBM-S	○	○	⊗	⊗	⊗	○	○	○				○	○	
SMG-EBD	○						○	⊗	⊗				○	

KOSG 2 FLUTE WITH CORNER RADIUS

GS-CR-EDS

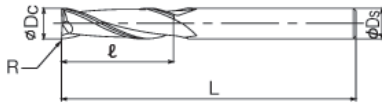

Unit:mm

EDP NO.	Dc	L	R	l	Ds	List Price (USD)
G2C010005	1	50	0.05	2.5	6	27.58
G2C010010	1	50	0.1	2.5	6	27.58
G2C010020	1	50	0.2	2.5	6	27.58
G2C010030	1	50	0.3	2.5	6	27.58
G2C015010	1.5	50	0.1	4	6	27.58
G2C015020	1.5	50	0.2	4	6	27.58
G2C015030	1.5	50	0.3	4	6	27.58
G2C015050	1.5	50	0.5	4	6	27.58
G2C020010	2	50	0.1	6	6	27.58
G2C020020	2	50	0.2	6	6	27.58
G2C020030	2	50	0.3	6	6	27.58
G2C020050	2	50	0.5	6	6	27.58
G2C025010	2.5	60	0.1	7	6	28.65
G2C025020	2.5	60	0.2	7	6	28.65
G2C025030	2.5	60	0.3	7	6	28.65
G2C025050	2.5	60	0.5	7	6	28.65
G2C030010	3	60	0.1	8	6	28.65
G2C030020	3	60	0.2	8	6	28.65
G2C030030	3	60	0.3	8	6	28.65
G2C030050	3	60	0.5	8	6	28.65
G2C030100	3	60	1	8	6	28.65
G2C040010	4	70	0.1	11	6	29.73
G2C040020	4	70	0.2	11	6	29.73
G2C040030	4	70	0.3	11	6	29.73
G2C040050	4	70	0.5	11	6	29.73
G2C040100	4	70	1	11	6	29.73
G2C050010	5	90	0.1	13	6	32.29
G2C050020	5	90	0.2	13	6	32.29
G2C050030	5	90	0.3	13	6	32.29
G2C050050	5	90	0.5	13	6	32.29
G2C050100	5	90	1	13	6	32.29
G2C060010C	6	60	0.1	15	6	28.65
G2C060020C	6	60	0.2	15	6	28.65
G2C060030C	6	60	0.3	15	6	28.65
G2C060050C	6	60	0.5	15	6	28.65
G2C060100C	6	60	1	15	6	28.65
G2C060150C	6	60	1.5	15	6	28.65
G2C060200C	6	60	2	15	6	28.65
G2C060010	6	90	0.1	15	6	32.29
G2C060020	6	90	0.2	15	6	32.29
G2C060030	6	90	0.3	15	6	32.29
G2C060050	6	90	0.5	15	6	32.29
G2C060100	6	90	1	15	6	32.29
G2C060150	6	90	1.5	15	6	32.29
G2C060200	6	90	2	15	6	32.29
G2C080020C	8	70	0.2	20	8	45.44
G2C080030C	8	70	0.3	20	8	45.44

Unit:mm

EDP NO.	Dc	L	R	l	Ds	List Price (USD)
G2C080050C	8	70	0.5	20	8	45.44
G2C080100C	8	70	1	20	8	45.44
G2C080150C	8	70	1.5	20	8	45.44
G2C080200C	8	70	2	20	8	45.44
G2C080010	8	100	0.1	20	8	48.83
G2C080020	8	100	0.2	20	8	48.83
G2C080030	8	100	0.3	20	8	48.83
G2C080050	8	100	0.5	20	8	48.83
G2C080100	8	100	1	20	8	48.83
G2C080150	8	100	1.5	20	8	48.83
G2C080200	8	100	2	20	8	48.83
G2C080250	8	100	2.5	20	8	48.83
G2C080300	8	100	3	20	8	48.83
G2C080350	8	100	3.5	20	8	48.83
G2C080050B	8	120	0.5	20	8	61.48
G2C080100B	8	120	1	20	8	61.48
G2C100050C	10	75	0.5	25	10	60.53
G2C100100C	10	75	1	25	10	60.53
G2C100010	10	100	0.1	25	10	66.72
G2C100020	10	100	0.2	25	10	66.72
G2C100030	10	100	0.3	25	10	66.72
G2C100050	10	100	0.5	25	10	66.72
G2C100100	10	100	1	25	10	66.72
G2C100150	10	100	1.5	25	10	66.72
G2C100200	10	100	2	25	10	66.72
G2C100250	10	100	2.5	25	10	66.72
G2C100300	10	100	3	25	10	66.72
G2C100400	10	100	4	25	10	66.72
G2C100050B	10	130	0.5	25	10	79.38
G2C100100B	10	130	1	25	10	79.38
G2C120050C	12	80	0.5	30	12	80.76
G2C120100C	12	80	1	30	12	80.76
G2C120010	12	110	0.1	30	12	86.62
G2C120020	12	110	0.2	30	12	86.62
G2C120030	12	110	0.3	30	12	86.62
G2C120050	12	110	0.5	30	12	86.62
G2C120100	12	110	1	30	12	86.62
G2C120150	12	110	1.5	30	12	86.62
G2C120200	12	110	2	30	12	86.62
G2C120250	12	110	2.5	30	12	86.62
G2C120300	12	110	3	30	12	86.62
G2C120400	12	110	4	30	12	86.62
G2C120500	12	110	5	30	12	86.62
G2C120050B	12	130	0.5	30	12	99.28
G2C120100B	12	130	1	30	12	99.28
G2C160050	16	150	0.5	32	16	221.03
G2C160100	16	150	1	32	16	221.03
G2C160200	16	150	2	32	16	221.03

KOSG CARBIDE ENDMILL

WORK MATERIAL	CARBON STEEL	ALLOY STEEL		STAINLESS STEELS	CAST IRON DUCTILE CAST IRON	COPPER ALLOYS	ALUMINUM ALLOYS	HEAT RESISTANT ALLOYS	PLASTIC
	PREHARDENED STEEL	TOOL STEEL							
Abbreviation	~ 40HRC		~ 60HRC	~ 65HRC	~ 35HRC	~ 350HRB			
GS-CR-EDS	○		○		○	○	○	○	

KOSG 2 FLUTE LONG NECK WITH CORNER RADIUS

GS-LN-CR-EDS

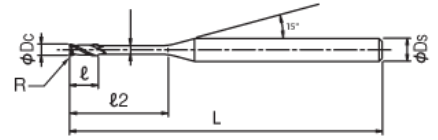

Unit:mm

Unit:mm

EDP NO.	Dc	L	l2	R	l	Ds	List Price (USD)
GS8560801K	0.8	45	4	0.1	1	4	30.30
GS8560802K	0.8	45	4	0.2	1	4	31.81
GS8560811K	0.8	45	6	0.1	1	4	30.30
GS8560813K	0.8	45	6	0.2	1	4	31.81
GS8560814K	0.8	45	8	0.1	1	4	31.81
GS8561026K	1	45	10	0.1	2	4	26.15
GS8561033K	1	45	4	0.1	2	4	26.15
GS8561034K	1	45	4	0.2	2	4	26.15
GS8561035K	1	45	4	0.3	2	4	26.15
GS8561036K	1	45	6	0.1	2	4	26.15
GS8561037K	1	45	6	0.2	2	4	26.15
GS8561004K	1	45	6	0.3	2	4	26.15
GS8561014K	1	45	8	0.1	2	4	26.15
GS8561024K	1	45	8	0.3	2	4	26.15
GS8561005K	1	45	10	0.2	2	4	26.15
GS8561029K	1	45	10	0.3	2	4	26.15
GS8561030K	1	45	12	0.1	2	4	26.15
GS8561006K	1	45	12	0.2	2	4	26.15
GS8561032K	1	45	12	0.3	2	4	26.15
GS8561204K	1.2	45	4	0.1	2	4	27.51
GS8561205K	1.2	45	4	0.2	2	4	27.51
GS8561206K	1.2	45	4	0.3	2	4	27.51
GS8561207K	1.2	45	6	0.1	2	4	27.51
GS8561208K	1.2	45	6	0.2	2	4	27.51
GS8561209K	1.2	45	6	0.3	2	4	27.51
GS8561210K	1.2	45	8	0.1	2	4	27.51
GS8561211K	1.2	45	8	0.2	2	4	27.51
GS8561212K	1.2	45	8	0.3	2	4	27.51
GS8561213K	1.2	45	10	0.1	2	4	27.51
GS8561214K	1.2	45	10	0.2	2	4	27.51
GS8561215K	1.2	45	10	0.3	2	4	27.51
GS8561216K	1.2	45	12	0.1	2	4	27.51
GS8561217K	1.2	45	12	0.2	2	4	27.51
GS8561218K	1.2	45	12	0.3	2	4	27.51
GS8561501K	1.5	45	4	0.1	2	4	27.51

EDP NO.	Dc	L	l2	R	l	Ds	List Price (USD)
GS8561510K	1.5	45	4	0.5	2	4	26.75
GS8561511K	1.5	45	6	0.1	2	4	26.75
GS8561515K	1.5	45	6	0.2	2	4	26.75
GS8561516K	1.5	45	6	0.3	2	4	26.75
GS8561517K	1.5	45	6	0.5	2	4	26.75
GS8561518K	1.5	45	8	0.1	2	4	26.75
GS8561519K	1.5	45	8	0.2	2	4	26.75
GS8561520K	1.5	45	8	0.3	2	4	26.75
GS8561521K	1.5	45	8	0.5	2	4	26.75
GS8561526K	1.5	45	10	0.1	2	4	26.75
GS8561527K	1.5	45	10	0.3	2	4	26.75
GS8561528K	1.5	45	10	0.5	2	4	26.75
GS8561529K	1.5	45	12	0.1	2	4	26.75
GS8561530K	1.5	45	12	0.3	2	4	26.75
GS8561531K	1.5	45	12	0.5	2	4	26.75
GS8561532K	1.5	50	16	0.2	2	4	26.75
GS8561533K	1.5	50	16	0.3	2	4	26.75
GS8561534K	1.5	55	20	0.3	2	4	28.14
GS8562044K	2	45	6	0.2	3	4	26.15
GS8562045K	2	45	6	0.3	3	4	26.15
GS8562046K	2	45	6	0.5	3	4	26.15
GS8562001K	2	45	8	0.1	3	4	27.36
GS8562027K	2	45	8	0.2	3	4	26.15
GS8562028K	2	45	8	0.3	3	4	26.15
GS8562049K	2	45	8	0.5	3	4	26.15
GS8562051K	2	45	9	0.5	3	4	26.15
GS8562029K	2	45	10	0.1	3	4	27.51
GS8562030K	2	45	10	0.2	3	4	27.51
GS8562031K	2	45	10	0.3	3	4	27.51
GS8562032K	2	45	12	0.2	3	4	27.51
GS8562033K	2	45	12	0.3	3	4	27.51
GS8562034K	2	50	16	0.2	3	4	27.51
GS8562035K	2	50	16	0.3	3	4	27.51
GS8562040K	2	50	16	0.5	3	4	26.75
GS8562036K	2	55	20	0.2	3	4	28.94
GS8562037K	2	55	20	0.3	3	4	28.94

KOSG CARBIDE ENDMILL

KOSG 2 FLUTE LONG NECK WITH CORNER RADIUS

GS-LN-CR-EDS

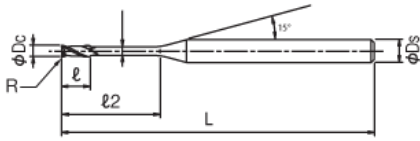

Unit:mm

EDP NO.	Dc	L	l2	R	l	Ds	List Price (USD)
GS8562039K	2	55	20	0.5	3	4	30.30
GS8562042K	2	60	25	0.3	3	4	31.81
GS8562043K	2	60	25	0.5	3	4	30.30
GS8562502K	2.5	45	10	0.2	3.7	4	31.81
GS8562503K	2.5	45	10	0.3	3.7	4	31.81
GS8562504K	2.5	45	10	0.5	3.7	4	26.15
GS8562505K	2.5	45	12	0.2	3.7	4	26.15
GS8562506K	2.5	45	12	0.3	3.7	4	26.15
GS8562507K	2.5	45	12	0.5	3.7	4	26.15
GS8562508K	2.5	50	16	0.2	3.7	4	26.15
GS8562509K	2.5	50	16	0.3	3.7	4	26.15
GS8562510K	2.5	50	16	0.5	3.7	4	26.15
GS8562511K	2.5	55	20	0.2	3.7	4	26.15
GS8562512K	2.5	55	20	0.3	3.7	4	26.15
GS8562513K	2.5	55	20	0.5	3.7	4	26.15
GS8563001K	3	55	8	0.2	4	6	26.15
GS8563002K	3	55	8	0.3	4	6	26.15
GS8563004K	3	55	8	0.5	4	6	26.15
GS8563003K	3	55	9	0.3	4	6	26.15
GS8563005K	3	55	9	0.5	4	6	27.51
GS8563011K	3	45	10	0.2	4.5	6	27.51
GS8563006K	3	55	10	0.3	4	6	27.51
GS8563007K	3	55	10	0.5	4	6	27.51
GS8563008K	3	55	12	0.3	4	6	27.51
GS8563009K	3	55	12	0.5	4	6	27.51
GS8563012K	3	55	16	0.2	4.5	6	27.51
GS8563010K	3	55	16	0.3	4	6	27.51
GS8563015K	3	55	16	0.5	4	6	27.51
GS8563013K	3	60	20	0.2	4.5	6	27.51
GS8563016K	3	55	20	0.3	4	6	27.51
GS8563025K	3	55	20	0.5	4	6	27.51
GS8563014K	3	65	25	0.5	4.5	6	27.51
GS8564001K	4	55	10	0.2	5	6	27.51
GS8564002K	4	55	12	0.2	5	6	27.51
GS8564003K	4	55	12	0.3	5	6	27.51

Unit:mm

EDP NO.	Dc	L	l2	R	l	Ds	List Price (USD)
GS8564005K	4	55	12	0.5	5	6	28.57
GS8564006K	4	55	12	1	5	6	28.57
GS8564007K	4	55	16	0.2	5	6	28.57
GS8564008K	4	55	16	0.3	5	6	28.57
GS8564015K	4	55	16	0.5	5	6	28.57
GS8564016K	4	55	16	1	5	6	28.57
GS8564017K	4	55	20	0.3	5	6	30.68
GS8564025K	4	55	20	0.5	5	6	30.68
GS8564026K	4	55	20	1	5	6	30.68
GS8564027K	4	55	25	0.3	5	6	32.22
GS8564028K	4	70	25	0.5	6	6	35.45
GS8566001K	6	60	15	0.2	7	6	31.76
GS8566002K	6	60	15	0.3	7	6	31.76
GS8566004K	6	60	15	0.5	7	6	31.76
GS8566006K	6	60	15	1	7	6	31.76
GS8566003K	6	60	20	0.3	7	6	33.43
GS8566005K	6	60	20	0.5	7	6	33.43
GS8566010K	6	60	20	1	7	6	30.52
GS8566015K	6	60	20	1.5	7	6	30.64
GS8568001K	8	60	15	0.5	9	8	37.47
GS8568002K	8	60	20	1	9	8	37.47
GS8568003K	8	60	25	0.3	9	8	37.47
GS8568004K	8	60	25	0.5	9	8	37.47
GS8568010K	8	60	25	1	9	8	37.47
GS8568015K	8	60	25	1.5	9	8	37.47
GS8570002K	10	70	25	1	11	10	51.19
GS8570003K	10	70	32	0.3	11	10	53.88
GS8570004K	10	70	32	0.5	11	10	53.88
GS8570010K	10	70	32	1	11	10	53.88
GS8570015K	10	70	32	1.5	11	10	53.88
GS8572002K	12	80	30	0.5	12	12	65.47
GS8572003K	12	80	30	1	12	12	65.47
GS8572004K	12	80	38	0.5	12	12	65.47
GS8572010K	12	80	38	1	12	12	65.47
GS8572015K	12	80	38	1.5	12	12	65.47

KOSG CARBIDE ENDMILL

WORK MATERIAL Abbreviation	CARBON STEEL	ALLOY STEEL			STAINLESS STEELS	CAST IRON DUCTILE CAST IRON	COPPER ALLOYS	ALUMINUM ALLOYS	HEAT RESISTANT ALLOYS	PLASTIC
	PREHARDENED STEEL	TOOL STEEL	~ 40HRC	~ 60HRC	~ 65HRC	~ 35HRC	~ 350HRB			
GS-LN-CR-EDS	⊗		○			○	⊗	○	○	

KOSG 3 FLUTE FOR ALUMINIUM

AL+MG-ET

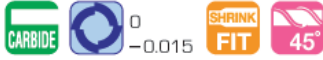
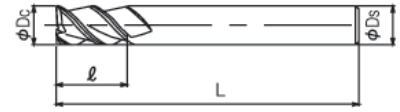

Unit:mm

Unit:mm

EDP NO.	Dc	L	ℓ	Ds	List Price (USD)
A3F 010 02	1	40	2	6	19.92
A3F 010 025		40	2.5	6	19.92
A3F 010		50	3	6	20.98
A3F 010 04		60	4	6	23.13
A3F 010 06		60	6	6	23.13
A3F 012	1.2	50	4	6	20.98
A3F 015 03	1.5	40	3	6	19.92
A3F 015		50	5	6	20.98
A3F 015 06		60	6	6	23.13
A3F 015 08	2	60	8	6	23.13
A3F 015 10		60	10	6	25.42
A3F 020 03		40	3	6	19.92
A3F 020	2	50	6	6	20.98
A3F 020 08		60	8	6	23.13
A3F 020 10		60	10	6	23.13
A3F 020 12	2.5	60	12	6	23.13
A3F 025 08		40	8	6	19.92
A3F 025		55	10	6	23.13
A3F 025 12	3	60	12	6	23.13
A3F 030 04		45	4	6	20.98
A3F 030 08		45	8	6	20.98
A3F 030	3	55	11	6	23.13
A3F 030 15		65	15	6	25.42
A3F 030 20		70	20	6	26.64
A3F 030 25	3.5	75	25	6	27.98
A3F 030 30		80	30	6	29.46
A3F 035		55	12	6	23.13
A3F 040 05	4	45	5	6	20.98
A3F 040 08		45	8	6	20.98
A3F 040 11		45	11	6	20.98
A3F 040	4	55	13	6	23.13
A3F 040 16		65	16	6	25.42
A3F 040 20		70	20	6	26.64
A3F 040 26	4.5	75	26	6	27.98
A3F 040 30		80	30	6	29.46
A3F 045		55	15	6	23.13
A3F 050 06	5	45	6	6	20.98
A3F 050		55	17	6	23.13
A3F 050 22		60	22	6	23.13
A3F 050 26	5.5	70	26	6	24.34
A3F 050 31		75	31	6	25.42
A3F 050 36		80	36	6	26.77
A3F 050 41	6	85	41	6	27.98
A3F 050 46		90	46	6	29.46
A3F 055		55	17	6	21.79
A3F 060 07	6	50	7	6	21.79
A3F 060 13		50	13	6	21.79
A3F 060		60	17	6	23.13
A3F 060 22	7	60	22	6	23.13
A3F 060 26		70	26	6	24.34
A3F 060 31		75	31	6	25.42
A3F 060 36	8	80	36	6	26.77
A3F 060 43		90	43	6	29.46
A3F 060 51		100	51	6	32.29
A3F 070	8	65	23	8	32.82
A3F 080 10		60	10	8	31.20
A3F 080 20		60	20	8	31.20

EDP NO.	Dc	L	ℓ	Ds	List Price (USD)
A3F 080	8	70	23	8	32.82
A3F 080 29		80	29	8	36.06
A3F 080 31		80	31	8	36.06
A3F 080 36		85	36	8	37.80
A3F 080 41		90	41	8	39.68
A3F 080 46		95	46	8	41.70
A3F 080 51		100	51	8	43.73
A3F 080 56		105	56	8	46.01
A3F 080 66		110	66	8	48.30
A3F 090		9	70	28	10
A3F 100 12	65		12	10	43.32
A3F 100 23	65		23	10	43.32
A3F 100	10	75	28	10	45.60
A3F 100 33		90	33	10	52.33
A3F 100 36		90	36	10	52.33
A3F 100 41		90	41	10	52.33
A3F 100 46		100	46	10	57.57
A3F 100 51		100	51	10	57.57
A3F 100 56	12	110	56	10	63.36
A3F 100 61		110	61	10	63.36
A3F 100 66		120	66	10	69.69
A3F 120 14	12	70	14	12	57.84
A3F 120 27		70	27	12	57.84
A3F 120		80	33	12	60.93
A3F 120 41		95	41	12	69.96
A3F 120 46		100	46	12	73.45
A3F 120 51		100	51	12	73.45
A3F 120 56	14	110	56	12	80.85
A3F 120 61		110	61	12	80.85
A3F 120 66		120	66	12	88.93
A3F 120 71	14	120	71	12	88.93
A3F 120 76		135	76	12	102.38
A3F 140		90	38	16	140.85
A3F 160 19	16	90	19	16	140.85
A3F 160 33		90	33	16	140.85
A3F 160		100	43	16	148.38
A3F 160 53		105	53	16	152.02
A3F 160 56		110	56	16	155.79
A3F 160 66		130	66	16	171.39
A3F 160 76	16	150	76	16	188.34
A3F 160 86		160	86	16	197.76
A3F 160 96		180	96	16	217.67
A3F 160 106	18	190	106	16	228.57
A3F 160 116		200	116	16	240.01
A3F 180		100	49	16	216.45
A3F 200 23	20	90	23	20	219.55
A3F 200 39		90	39	20	219.55
A3F 200		100	49	20	231.13
A3F 200 56		110	56	20	242.56
A3F 200 66		130	66	20	266.91
A3F 200 76		150	76	20	293.54
A3F 200 86		160	86	20	308.21
A3F 200 96		180	96	20	339.02
A3F 200 106		190	106	20	356.11
A3F 200 116		200	116	20	373.86
A3F 200 126	220	126	20	411.26	

WORK MATERIAL	CARBON STEEL	ALLOY STEEL	STAINLESS STEELS	CAST IRON DUCTILE CAST IRON	COPPER ALLOYS	ALUMINUM ALLOYS	HEAT RESISTANT ALLOYS	PLASTIC
	PREHARDENED STEEL	TOOL STEEL						
Abbreviation	~ 40HRC		~ 60HRC	~ 65HRC	~ 35HRC	~ 350HRB		
AL+MG-ET								

KOSG 2 FLUTE FOR ALUMINIUM

AL+MG-ED

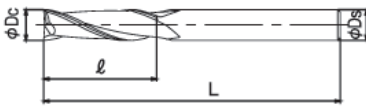

Unit:mm

EDP NO.	Dc	L	l	Ds	List Price (USD)
A2F 010	1	50	3	6	19.11
A2F 010 06		60	6	6	20.98
A2F 012	1.2	50	4	6	19.11
A2F 015	1.5	50	5	6	19.11
A2F 015 08		60	8	6	20.98
A2F 020	2	50	6	6	19.11
A2F 020 10		60	10	6	20.98
A2F 025	2.5	55	10	6	20.98
A2F 030	3	55	11	6	20.98
A2F 030 15		65	15	6	23.13
A2F 040	4	55	13	6	20.98
A2F 040 16		65	16	6	23.13
A2F 050	5	55	17	6	20.98
A2F 050 22		60	22	6	20.98
A2F 060	6	60	17	6	20.98

Unit:mm



EDP NO.	Dc	L	l	Ds	List Price (USD)
A2F 060 26	6	70	26	6	22.19
A2F 070	7	65	23	8	29.86
A2F 080	8	70	23	8	29.86
A2F 080 31		80	31	8	32.82
A2F 100	10	75	28	10	41.43
A2F 100 36		90	36	10	47.63
A2F 120	12	80	33	12	55.43
A2F 120 41		95	41	12	63.63
A2F 140	14	90	38	14	94.85
A2F 140 S16		90	38	16	128.07
A2F 160	16	100	43	16	134.92
A2F 160 53		105	53	16	141.65
A2F 180	18	100	49	16	196.82
A2F 200	20	100	49	20	210.14
A2F 200 56		110	56	20	220.49

KOSG 3 FLUTE ROUGHING FOR ALUMINIUM

AL+MG-REE

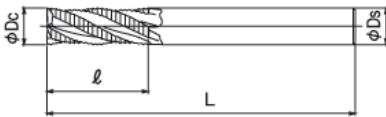

Unit:mm



EDP NO.	Dc	L	l	Ds	List Price (USD)
A3R 060	6	60	15	6	31.48
A3R 060 25		80	25	6	36.59
A3R 080	8	65	20	8	38.87
A3R 080 30		90	30	8	46.82
A3R 100	10	70	25	10	53.82
A3R 100 40		100	40	10	68.07
A3R 120	12	80	30	12	72.11
A3R 120 50		110	50	12	95.52
A3R 140	14	90	35	16	166.55
A3R 160		100	42	16	175.44
A3R 160 52	16	150	52	16	222.78
A3R 180	18	100	45	20	255.87
A3R 200	20	100	48	20	273.23
A3R 200 55		160	55	20	364.31

WORK MATERIAL	CARBON STEEL	ALLOY STEEL			STAINLESS STEELS	CAST IRON DUCTILE CAST IRON	COPPER ALLOYS	ALUMINUM ALLOYS	HEAT RESISTANT ALLOYS	PLASTIC
	PREHARDENED STEEL	TOOL STEEL	~ 40HRC	~ 60HRC	~ 65HRC	~ 35HRC	~ 350HRB			
Abbreviation										
AL+MG-ED							⊙	⊙		○
AL+MG-REE							⊙	⊙		

HSS END MILLS



Page	Abbreviation	Specification	Surface Treatment	Flute	Stocked Size
72	HY-PRO V-EDS	Square	V	2	1~32
	HY-PRO V-CC-EMS	Square	V	4	2~32
73	HY-PRO V-REES	Roughing	V	4	6~32
	HY-PRO V-EBD	Ball Nose	V	2	R0.5~R16
74	HY-PRO EDS	Square	-	2	1~32
	HY-PRO EDL	Square	-	2	3~32
75	HY-PRO CC-EMS	Square	-	4	2~32
	HYP-PRO CC-EML	Square	-	4	3~32
76	HYP-PRO EX-REES/EX-REEL	Roughing	-	2	6~32
	HY-PRO EBD	Ball Nose	-	2	R0.5~R16

HSS END MILLS CONTENTS



**HY-PRO HSS-Co.8
2 FLUTE SHORT WITH V COATING**

HY-PRO V-EDS

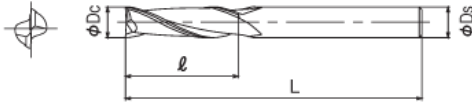

**HY-PRO HSS-Co.8
4 FLUTE SHORT WITH V COATING**

HY-PRO V-CC-EMS



Unit:mm

EDP NO.	Dc	L	l	Ds	List Price (USD)
H688002	1	45	2.5	6	19.18
H688003	1.5	45	4	6	15.81
H688004	2	50	5	6	13.49
H688005	2.5	50	6	6	14.34
H688006	3	50	8	6	11.85
H688007	3.5	60	8	8	14.34
H688008	4	60	8	8	11.73
H688009	4.5	60	10	8	14.34
H688010	5	60	10	8	11.85
H688011	5.5	60	12	8	14.34
H688012	6	60	12	8	11.85
H688013	6.5	60	14	10	16.62
H688014	7	60	14	10	14.58
H688015	7.5	60	14	10	16.62
H688016	8	60	14	10	14.58
H688017	8.5	70	18	10	18.05
H688018	9	70	18	10	16.33
H688019	9.5	70	18	10	18.05
H688020	10	70	18	10	16.33
H688021	11	80	22	12	21.73
H688022	12	80	22	12	21.86
H688023	13	85	26	12	27.60
H688024	14	90	26	16	27.60
H688025	15	95	30	16	30.65
H688026	16	95	30	16	33.04
H688027	17	95	34	16	39.32
H688028	18	95	34	16	39.44
H688029	19	110	38	20	47.07
H688030	20	110	38	20	47.07
H688032	22	110	45	20	58.87
H688034	24	120	50	25	73.70
H688035	25	120	50	25	73.70
H688038	28	125	55	25	82.37
H688040	30	125	55	25	100.25
H688042	32	145	60	32	139.45

~for HY-PRO VE-EDS stock availability please check with sales representative



Unit:mm

EDP NO.	Dc	L	l	Ds	List Price (USD)
H688204	2	50	8	6	14.34
H688205	2.5	50	10	6	14.34
H688206	3	50	10	6	11.73
H688207	3.5	60	12	8	14.34
H688208	4	60	12	8	11.85
H688209	4.5	60	15	8	14.34
H688210	5	60	15	8	11.85
H688211	5.5	60	15	8	14.34
H688212	6	60	15	8	11.85
H688213	6.5	60	20	10	16.62
H688214	7	60	20	10	14.58
H688215	7.5	60	20	10	16.62
H688216	8	60	20	10	14.58
H688217	8.5	70	25	10	18.05
H688218	9	70	25	10	16.33
H688219	9.5	70	25	10	18.05
H688220	10	70	25	10	16.33
H688221	11	80	30	12	21.73
H688222	12	80	30	12	21.86
H688223	13	85	35	12	27.60
H688224	14	90	35	16	27.60
H688225	15	95	40	16	30.65
H688226	16	95	40	16	33.04
H688227	17	95	40	16	39.32
H688228	18	95	40	16	39.44
H688229	19	110	45	20	47.07
H688230	20	110	45	20	47.07
H688232	22	110	45	20	58.87
H688234	24	120	50	25	73.70
H688235	25	120	50	25	73.70
H688238	28	125	55	25	82.37
H688240	30	125	55	25	100.25
H688242	32	145	60	32	139.45

HY-PRO HSS END MILLS

* for stock availability please check with sales representative

WORK MATERIAL	CARBON STEELS	ALLOY STEELS	PREHARDENED STEELS	STAINLESS	CAST IRON	COPPER	ALUMINUM
	PREHARDENED STEELS	TOOL STEELS	HARDENED STEELS	STEELS	DUCTILE CASTIRON	ALLOYS	ALLOYS
Abbreviation	~ 40HRC		~ 45HRC	~ 35HRC	~ 350HB		
V-EDS	⊙			⊙	⊙	○	○
V-CC-EMS	⊙			⊙	⊙	○	○

HY-PRO HSS-Co.8
ROUGHING SHORT WITH V COATING



HY-PRO V-REES



HY-PRO HSS-Co.8
4 FLUTE SHORT WITH V COATING



HY-PRO V-EBD

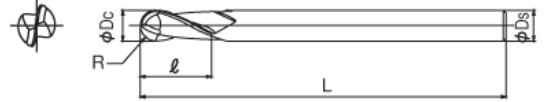

Unit:mm



EDP NO.	Dc	L	ℓ	Ds	Z	List Price (USD)
H681506	6	57	13	6	4	28.29
H681507	7	66	16	10	4	29.92
H681508	8	69	19	10	4	29.92
H681509	9	69	19	10	4	33.62
H681510	10	72	22	10	4	33.62
H681511	11	79	22	12	4	44.04
H681512	12	83	26	12	4	44.04
H681513	13	83	26	12	4	53.09
H681514	14	83	26	12	4	53.09
H681516	16	92	32	16	4	58.21
H681518	18	92	32	16	4	70.01
H681520	20	104	38	20	4	81.82
H681522	22	104	38	20	5	97.02
H681524	24	121	45	25	5	119.04
H681525	25	121	45	25	5	119.04
H681528	28	121	45	25	5	147.80
H681530	30	121	45	25	5	177.10
H681532	32	133	53	32	5	220.45

Unit:mm



EDP NO.	Dc	L	ℓ	Ds	List Price (USD)
H683061	R0.5x1	50	2.5	6	35.66
H683062	R1x2	50	5	6	25.46
H683063	R1.5x3	60	8	6	22.90
H683064	R2x4	70	8	6	22.90
H683065	R2.5x6	80	10	6	22.90
H683066	R3x6	90	12	6	22.90
H683067	R3.5x7	90	14	6	24.07
H683068	R4x8	100	14	8	24.07
H683069	R4.5x9	100	18	8	30.30
H683070	R5x10	100	18	10	30.30
H683071	R5.5x11	100	22	10	37.97
H683072	R6x12	110	22	12	37.97
H683073	R6.5x13	110	26	12	41.73
H683074	R7x14	110	26	12	41.73
H683075	R7.5x15	110	30	12	49.54
H683076	R8x16	140	30	16	56.11
H683078	R9x18	140	34	16	64.69
H683080	R10x20	160	38	20	77.36
H683085	R12.5x25	180	50	25	112.63
H683090	R15x30	180	55	25	155.76
H683092	R16x32	180	60	32	194.27

~ For VEBD stock availability please check with sales representative

* For stock availability please check with sales representative

WORK MATERIAL Abbreviation	CARBON STEELS PREHARDENED STEELS	ALLOY STEELS TOOL STEELS	PREHARDENED STEELS HARDENED STEELS	STAINLESS STEELS	CAST IRON DUCTILE CASTIRON	COPPER ALLOYS	ALUMINUM ALLOYS
	~ 40HRC		~ 45HRC	~ 35HRC	~ 350HB		
V-REES	○			○	○	○	○
V-EBD	○			○	○	○	○

HY-PRO HSS-Co.8
2 FLUTE SHORT

HY-PRO EDS

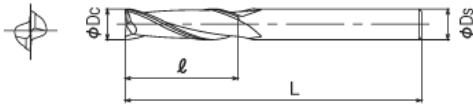

HY-PRO HSS-Co.8
2 FLUTE LONG

HY-PRO EDL



HSS C

Unit:mm

EDP NO.	Dc	L	l	Ds	List Price (USD)	
H80001	1	45	2.5	6	14.40	*
H80003	1.5	45	4	6	12.16	*
H80004	2	50	5	6	10.12	
H80005	2.5	50	6	6	10.85	
H80006	3	50	8	6	8.93	
H80007	3.5	60	8	8	10.88	*
H80008	4	60	8	8	9.03	
H80009	4.5	60	10	8	10.88	
H80010	5	60	10	8	9.03	
H80011	5.5	60	12	8	10.88	
H80012	6	60	12	8	9.03	
H80013	6.5	60	14	10	13.41	*
H80014	7	60	14	10	10.96	
H80015	7.5	60	14	10	13.41	*
H80016	8	60	14	10	10.96	
H80017	8.5	70	18	10	14.99	*
H80018	9	70	18	10	12.32	
H80019	9.5	70	18	10	14.99	*
H80020	10	70	18	10	12.32	
H80021	11	80	22	12	16.44	
H80022	12	80	22	12	16.52	
H80023	13	85	26	12	21.01	
H80024	14	90	26	16	21.01	*
H80025	15	95	30	16	23.13	*
H80026	16	95	30	16	25.10	
H80027	17	95	34	16	29.72	
H80028	18	95	34	16	29.87	
H80029	19	110	38	20	35.62	*
H80030	20	110	38	20	35.62	
H80032	22	110	45	20	44.57	
H80034	24	120	50	25	55.92	*
H80035	25	120	50	25	55.92	*
H80038	28	125	55	25	62.31	
H80040	30	125	55	25	75.97	
H80042	32	145	60	32	105.48	*

HSS Co

Unit:mm

EDP NO.	Dc	L	l	Ds	List Price (USD)	
H80106	3	60	15	6	11.65	
H80108	4	60	20	8	11.65	*
H80110	5	60	25	8	11.65	*
H80112	6	60	25	8	11.65	*
H80114	7	75	35	10	14.29	*
H80116	8	75	35	10	14.29	*
H80118	9	90	45	10	16.12	*
H80120	10	90	45	10	16.12	*
H80121	11	105	55	12	21.49	*
H80122	12	105	55	12	21.49	*
H80125	14	110	55	16	27.26	*
H80126	16	120	65	16	32.59	*
H80128	18	120	65	16	38.82	*
H80130	20	140	75	20	46.25	*
H80132	22	140	75	20	57.87	*
H80134	24	160	90	25	72.72	*
H80135	25	160	90	25	72.72	*
H80138	28	160	90	25	86.25	*
H80140	30	160	90	25	105.07	*
H80142	32	180	95	32	146.15	*

HY-PRO HSS END MILLS

* For stock availability please check with sales representative

WORK MATERIAL Abbreviation	CARBON STEELS PREHARDENED STEELS	ALLOY STEELS TOOL STEELS	PREHARDENED STEELS HARDENED STEELS	STAINLESS STEELS	CAST IRON DUCTILE CASTIRON	COPPER ALLOYS	ALUMINUM ALLOYS
	~ 40HRC		~ 45HRC	~ 35HRC	~ 350HB		
EDS	○			○	○	⊗	⊗
EDL	○			○	○	⊗	⊗

HY-PRO HSS-Co.8
4 FLUTE SHORT



HY-PRO CC-EMS

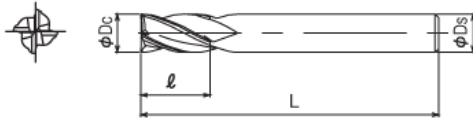

HY-PRO HSS-Co.8
4 FLUTE LONG



HY-PRO CC-EML



Unit:mm



EDP NO.	Dc	L	l	Ds	List Price (USD)
H80704	2	50	8	6	10.14
H80705	2.5	50	10	6	10.85
H80706	3	50	10	6	8.93
H80707	3.5	60	12	8	10.88
H80708	4	60	12	8	9.03
H80709	4.5	60	15	8	10.88
H80710	5	60	15	8	9.03
H80711	5.5	60	15	8	10.88
H80712	6	60	15	8	9.03
H80713	6.5	60	20	10	13.41
H80714	7	60	20	10	10.96
H80715	7.5	60	20	10	13.41
H80716	8	60	20	10	10.96
H80717	8.5	70	25	10	14.99
H80718	9	70	25	10	12.32
H80719	9.5	70	25	10	14.99
H80720	10	70	25	10	12.32
H80721	11	80	30	12	16.44
H80722	12	80	30	12	16.52
H80723	13	85	35	12	21.01
H80724	14	90	35	16	21.01
H80725	15	95	40	16	23.13
H80726	16	95	40	16	25.1
H80727	17	95	40	16	29.72
H80728	18	95	40	16	29.87
H80729	19	110	45	20	35.62
H80730	20	110	45	20	35.62
H80732	22	110	45	20	44.57
H80734	24	120	50	25	55.92
H80735	25	120	50	25	55.92
H80738	28	125	55	25	62.31
H80740	30	125	55	25	75.97
H80742	32	145	60	32	105.48

Unit:mm



EDP NO.	Dc	L	l	Ds	List Price (USD)
H81006	3	60	15	6	11.65
H81008	4	60	20	8	11.65
H81010	5	60	25	8	11.65
H81012	6	60	25	8	11.65
H81014	7	75	35	10	14.29
H81016	8	75	35	10	14.29
H81018	9	90	45	10	16.12
H81020	10	90	45	10	16.12
H81021	11	105	55	12	21.49
H81022	12	105	55	12	21.49
H81024	14	110	55	16	27.26
H81026	16	120	65	16	32.59
H81028	18	120	65	16	38.82
H81030	20	140	75	20	46.25
H81032	22	140	75	20	57.87
H81034	24	160	90	25	72.72
H81035	25	160	90	25	72.72
H81038	28	160	90	25	86.25
H81040	30	160	90	25	105.07
H81042	32	180	95	32	146.15

HY-PRO HSS END MILLS

* For stock availability please check with sales representative

WORK MATERIAL Abbreviation	CARBON STEELS PREHARDENED STEELS	ALLOY STEELS TOOL STEELS	PREHARDENED STEELS HARDENED STEELS	STAINLESS STEELS	CAST IRON DUCTILE CASTIRON	COPPER ALLOYS	ALUMINUM ALLOYS
	~ 40HRC		~ 45HRC	~ 35HRC	~ 350HB		
CC-EMS	○			○	○	⊗	⊗
CC-EML	○			○	○	⊗	⊗

**HY-PRO HSS-Co.8
ROUGHING SHORT & LONG**

HY-PRO EX-REES/EX-REEL 

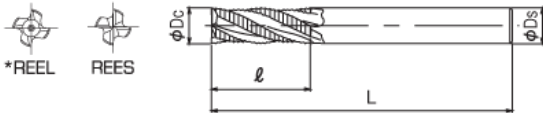

**HY-PRO HSS-Co.8
BALL NOSE**

HY-PRO EBD 

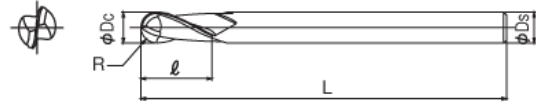

 **HY-PRO EX-REES**

Unit:mm

EDP NO.	Dc	L	ℓ	Ds	Z	List Price (USD)
H81506	6	57	13	6	4	20.82
H81507	7	66	16	10	4	22.31
H81508	8	69	19	10	4	22.31
H81509	9	69	19	10	4	25.75
H81510	10	72	22	10	4	25.75
H81511	11	79	22	12	4	33.04
H81512	12	83	26	12	4	33.04
H81513	13	83	26	12	4	40.36
H81514	14	83	26	12	4	40.36
H81516	16	92	32	16	4	41.67
H81518	18	92	32	16	4	50.44
H81520	20	104	38	20	4	59.23
H81522	22	104	38	20	5	71.05
H81524	24	121	45	25	5	82.62
H81525	25	121	45	25	5	82.62
H81528	28	121	45	25	5	109.26
H81530	30	121	45	25	5	131.77
H81532	32	133	53	32	5	158.83

 **HY-PRO EBD**

Unit:mm

EDP NO.	Dc	L	ℓ	Ds	List Price (USD)
H80760	R0.5 x 1	50	2.5	6	28.77
H80802	R 1 x 2	50	5	6	20.53
H80803	R 1.5 x 3	60	8	6	18.44
H80804	R 2 x 4	70	8	6	18.44
H80805	R 2.5 x 5	80	10	6	18.44
H80806	R 3 x 6	90	12	6	18.44
H80807	R 3.5 x 7	90	14	6	19.60
H80808	R 4 x 8	100	14	8	19.60
H80809	R 4.5 x 9	100	18	8	22.93
H80810	R 5 x 10	100	18	10	22.93
H80811	R 5.5 x 11	100	22	10	29.21
H80812	R 6 x 12	110	22	12	29.21
H80813	R 6.5 x 13	110	26	12	35.49
H80814	R 7 x 14	110	26	12	35.49
H80815	R 7.5 x 15	110	30	12	39.42
H80816	R 8 x 16	140	30	16	42.75
H80818	R 9 x 18	140	34	16	50.98
H80820	R 10 x 20	160	38	20	60.78
H80825	R 12.5 x 25	180	50	25	79.13
H80830	R 15 x 30	180	55	25	108.22
H82932	R 16 x 32	180	60	32	138.99

~ for HY-PRO EBD stock availability please check with sales representative

HY-PRO HSS END MILLS

 **HY-PRO EX-REEL**

Unit:mm

EDP NO.	Dc	L	ℓ	Ds	Z	List Price (USD)
H80846	6	68	24	6	4	26.87
H80847	7	80	30	10	4	28.70
H80848	8	88	38	10	4	28.70
H80849	9	88	38	10	4	36.16
H80850	10	95	45	10	4	36.16
H80851	11	102	45	12	4	47.76
H80852	12	110	53	12	4	47.76
H80853	13	110	53	12	4	56.11
H80854	14	110	53	12	4	56.11
H80856	16	123	63	16	4	64.90
H80858	18	123	63	16	4	76.50
H80860	20	141	75	20	4	78.46
H80862	22	141	75	20	5	94.45
H80864	24	166	90	25	5	127.50
H80865	25	166	90	25	5	127.50
H80868	28	166	90	25	5	153.72
H80870	30	166	90	25	5	186.36
H80872	32	186	106	32	5	228.53

* For stock availability please check with sales representative

WORK MATERIAL Abbreviation	CARBON STEELS PREHARDENED STEELS	ALLOY STEELS TOOL STEELS	PREHARDENED STEELS HARDENED STEELS	STAINLESS STEELS	CAST IRON DUCTILE CASTIRON	COPPER ALLOYS	ALUMINUM ALLOYS
	~ 40HRC		~ 45HRC	~ 35HRC	~ 350HB		
EX-REES/EX-REEL	○			○	○	⊗	⊗
EBD	○			○	○	⊗	⊗



SOMTA



Page	Abbreviation	Specification	Surface Treatment	Stocked Size
80-81	101,102	STRAIGHT SHANK JOBBER DRILL	BLUE FINISH	0.3~20
82	1X5	X-RATIO STRAIGHT SHANK JOBBER DRILL	BLUE FINISH	3~13
83	177	NDX JOBBER DRILL-HEAVY DUTY	GOLD OXIDE	1~13
84	175,176	REDUCED SHANK(ELECTRICIANS) DRILLS	BLUE FINISH	11~25.4
85	116, 117	STRAIGHT SHANK LONG SERIES DRILL	BLUE FINISH	1~16
86	121, 122, 123, 124, 125,126	STRAIGHT SHANK EXTRA LENGTH DRILLS	BLUE FINISH	1.5~13
87	201, 202, 203, 204	MORSE TAPER SHANK DRILL	BLUE FINISH	3~50
88	242, 244	MTS EXTRA LENGTH DRILL	BLUE FINISH	10~30
89	184	NC SPOT DRILL	TiALN	3~20
89	114	TYPE A CENTRE DRILL	-	0.8~10
90	701	PARALLEL HAND REAMERS	-	1.5~38
91	731	HAND TAPER PIN REAMERS	-	2~25
92	751, 752	PARALLEL SHANK MACHINE CHUCKING REAMERS	-	2~20

SOMTA CONTENTS



GENERAL PURPOSE



STRAIGHT SHANK JOBBER DRILLS

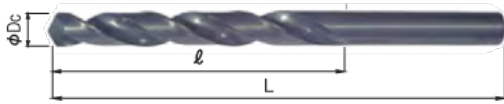

DIN 338

Unit:mm

EDP NO.	Dc	ℓ	L	List Price (USD)
1010030-S0	0.3	3	19	1.19
1010035-S0	0.35	4	19	1.08
1020040-S0	0.397(1/64")	5	20	0.42
1010040-S0	0.4	5	20	1.08
1010045-S0	0.45	5	20	0.98
1010050-S0	0.5	6	22	1.01
1010055-S0	0.55	7	24	0.91
1010060-S0	0.6	7	24	0.91
1010062-S0	0.62	8	26	0.83
1010070-S0	0.7	9	28	0.83
1010075-S0	0.75	9	28	0.83
1020079-S0	0.794(1/32")	10	30	0.87
1010080-S0	0.8	10	30	0.83
1010088-S0	0.88	11	32	0.83
1010090-S0	0.9	11	32	0.83
1010092-S0	0.92	11	32	0.83
1010100-S0	1	12	34	0.87
1010105-S0	1.05	12	34	0.87
1010110-S0	1.1	14	36	0.87
1010115-S0	1.15	14	36	0.87
1020119-S0	1.191(3/64")	16	38	0.64
1010120-S0	1.2	16	38	0.87
1010125-S0	1.25	16	38	0.87
1010130-S0	1.3	16	38	0.87
1010135-S0	1.35	18	40	0.87
1010140-S0	1.4	18	40	0.87
1010145-S0	1.45	18	40	0.87
1010150-S0	1.5	18	40	0.83
1010155-S0	1.55	20	43	0.83
1020159-S0	1.587(1/16")	20	43	0.82
1010160-S0	1.6	20	43	0.83
1010165-S0	1.65	20	43	0.83
1010170-S0	1.7	20	43	0.83
1010175-S0	1.75	22	46	0.83
1010180-S0	1.8	22	46	0.83
1010185-S0	1.85	22	46	0.83
1010190-S0	1.9	22	46	0.83
1010195-S0	1.95	24	49	0.96
1020198-S0	1.984(5/64")	24	49	0.82
1010200-S0	2	24	49	0.96
1010205-S0	2.05	24	49	0.96
1010210-S0	2.1	24	49	0.96
1010215-S0	2.15	27	53	0.96
1010220-S0	2.2	27	53	0.96
1010225-S0	2.25	27	53	0.96
1010230-S0	2.3	27	53	0.96
1010235-S0	2.35	27	53	0.96
1020238-S0	2.381(3/32")	30	57	0.82
1010240-S0	2.4	30	57	0.96
1010245-S0	2.45	30	57	0.96
1010250-S0	2.5	30	57	0.96
1010255-S0	2.55	30	57	0.96
1010260-S0	2.6	30	57	0.96
1010265-S0	2.65	30	57	0.96
1010270-S0	2.7	33	61	0.96
1010275-S0	2.75	33	61	0.96
1020278-S0	2.778(7/64")	33	61	0.95
1010280-S0	2.8	33	61	0.96
1010285-S0	2.85	33	61	0.96
1010290-S0	2.9	33	61	0.96
1010295-S0	2.95	33	61	0.96
1010300-S0	3	33	61	1.11
1010310-S0	3.1	36	65	1.11
1020318-S0	3.175(1/8")	36	65	1.63

Unit:mm

EDP NO.	Dc	ℓ	L	List Price (USD)
1010320-S0	3.2	36	65	1.11
1010325-S0	3.25	36	65	1.11
1010330-S0	3.3	36	65	1.11
1010340-S0	3.4	39	70	1.11
1010350-S0	3.5	39	70	1.04
1020357-S0	3.572(9/64")	39	70	1.9
1010360-S0	3.6	39	70	1.04
1010370-S0	3.7	39	70	1.04
1010380-S0	3.8	43	75	1.04
1010390-S0	3.9	43	75	1.04
1020397-S0	3.969(5/32")	43	75	1.95
1010400-S0	4	43	75	1.05
1010410-S0	4.1	43	75	1.05
1010420-S0	4.2	43	75	1.05
1010425-S0	4.25	43	75	1.05
1010430-S0	4.3	47	80	1.05
1020437-S0	4.366(11/64")	47	80	2.27
1010440-S0	4.4	47	80	1.05
1010450-S0	4.5	47	80	2.13
1010460-S0	4.6	47	80	2.13
1010470-S0	4.7	47	80	2.13
1020476-S0	4.762(3/16")	52	86	2.3
1010480-S0	4.8	52	86	2.13
1010490-S0	4.9	52	86	2.13
1010500-S0	5	52	86	2.35
1010510-S0	5.1	52	86	2.35
1020516-S0	5.159(13/64")	52	86	2.77
1010520-S0	5.2	52	86	2.35
1010525-S0	5.25	52	86	2.35
1010530-S0	5.3	52	86	2.35
1010540-S0	5.4	57	93	2.35
1010550-S0	5.5	57	93	2.74
1020556-S0	5.556(7/32")	57	93	3.01
1010560-S0	5.6	57	93	2.74
1010570-S0	5.7	57	93	2.74
1010575-S0	5.75	57	93	2.74
1010580-S0	5.8	57	93	2.74
1010590-S0	5.9	57	93	2.74
1020595-S0	5.953(15/64")	57	93	3.28
1010600-S0	6	57	93	3.11
1010610-S0	6.1	63	101	3.11
1010620-S0	6.2	63	101	3.11
1010625-S0	6.25	63	101	3.11
1010630-S0	6.3	63	101	3.11
1020635-S0	6.350(1/4")	63	101	3.65
1010640-S0	6.4	63	101	3.11
1010650-S0	6.5	63	101	3.47
1010660-S0	6.6	63	101	3.47
1010670-S0	6.7	63	101	3.47
1020675-S0	6.747(17/64")	69	109	4.16
1010675-S0	6.75	69	109	3.47
1010680-S0	6.8	69	109	3.47
1010690-S0	6.9	69	109	3.47
1010700-S0	7	69	109	4.06
1010710-S0	7.1	69	109	4.06
1020714-S0	7.144(9/32")	69	109	4.59
1010720-S0	7.2	69	109	4.06
1010730-S0	7.3	69	109	4.06
1010740-S0	7.4	69	109	4.06
1010750-S0	7.5	69	109	4.59
1020754-S0	7.541(19/64")	75	117	5.24
1010760-S0	7.6	75	117	4.59
1010770-S0	7.7	75	117	4.59
1010780-S0	7.8	75	117	4.59

SOMTA HSS DRILLS

RECOMMENDATION CUTTING CONDITIONS

Please refer to SOMTA catalogue



GENERAL PURPOSE

STRAIGHT SHANK JOBBER DRILLS

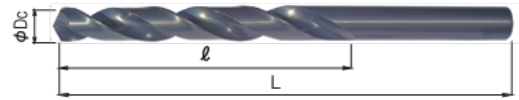

Unit:mm

EDP NO.	Dc	ℓ	L	List Price (USD)
1010790-S0	7.9	75	117	4.59
1020794-S0	7.937 (5/16")	75	117	5.35
1010800-S0	8	75	117	5.21
1010810-S0	8.1	75	117	5.21
1010820-S0	8.2	75	117	5.21
1010825-S0	8.25	75	117	5.21
1010830-S0	8.3	75	117	5.21
1020833-S0	8.334 (21/64")	75	117	6.03
1010840-S0	8.4	75	117	5.21
1010850-S0	8.5	75	117	5.72
1010860-S0	8.6	81	125	5.72
1010870-S0	8.7	81	125	5.72
1020873-S0	8.731 (11/32")	81	125	7.01
1010875-S0	8.75	81	125	5.72
1010880-S0	8.8	81	125	5.72
1010890-S0	8.9	81	125	5.72
1010900-S0	9	81	125	6.42
1010910-S0	9.1	81	125	6.42
1020913-S0	9.128 (23/64")	81	125	7.47
1010920-S0	9.2	81	125	6.42
1010925-S0	9.25	81	125	6.42
1010930-S0	9.3	81	125	6.42
1010940-S0	9.4	81	125	6.42
1010950-S0	9.5	81	125	7.07
1020953-S0	9.525 (3/8")	87	133	7.31
1010960-S0	9.6	87	133	7.07
1010970-S0	9.7	87	133	7.07
1010975-S0	9.75	87	133	7.07
1010980-S0	9.8	87	133	7.07
1010990-S0	9.9	87	133	7.07
1020992-S0	9.922 (25/64")	87	133	8.51
1011000-S0	10	87	133	7.92
1011010-S0	10.1	87	133	7.92
1011020-S0	10.2	87	133	7.92
1011025-S0	10.25	87	133	7.92
1011030-S0	10.3	87	133	7.92
1021032-S0	10.319 (13/32")	87	133	9.29
1011040-S0	10.4	87	133	7.92
1011050-S0	10.5	87	133	8.76
1011060-S0	10.6	87	133	8.76
1011070-S0	10.7	94	142	8.76
1021072-S0	10.716 (27/64")	94	142	10.17
1011075-S0	10.75	94	142	8.76
1011080-S0	10.8	94	142	8.76
1011090-S0	10.9	94	142	8.76
1011100-S0	11	94	142	9.70
1011110-S0	11.1	94	142	9.70
1021111-S0	11.112 (7/16")	94	142	11.28
1011120-S0	11.2	94	142	9.70
1011130-S0	11.3	94	142	9.70
1011140-S0	11.4	94	142	9.70

Unit:mm

EDP NO.	Dc	ℓ	L	List Price (USD)
1011150-S0	11.5	94	142	10.72
1021151-S0	11.509 (29/64")	94	142	11.50
1011160-S0	11.6	94	142	10.72
1011170-S0	11.7	94	142	10.72
1011180-S0	11.8	94	142	10.72
1011190-S0	11.9	101	151	10.72
1021191-S0	11.906 (15/32")	101	151	12.16
1011200-S0	12	101	151	11.57
1011210-S0	12.1	101	151	11.57
1011220-S0	12.2	101	151	11.57
1011230-S0	12.3	101	151	11.57
1011240-S0	12.4	101	151	11.57
1011250-S0	12.5	101	151	12.86
1011260-S0	12.6	101	151	12.86
1011270-S0	12.7	101	151	12.86
1021270-S0	12.700 (1/2")	101	151	13.31
1011275-S0	12.75	101	151	13.26
1011280-S0	12.8	101	151	12.86
1011290-S0	12.9	101	151	12.86
1011300-S0	13	101	151	13.36
1021310-S0	13.097 (33/64")	101	151	15.96
1011310-S0	13.1	101	151	13.36
1011320-S0	13.2	101	151	13.36
1011325-S0	13.25	108	160	13.36
1011330-S0	13.3	108	160	13.36
1011340-S0	13.4	108	160	13.36
1021349-S0	13.494 (17/32")	108	160	18.46
1011350-S0	13.5	108	160	18.17
1011360-S0	13.6	108	160	18.17
1011370-S0	13.7	108	160	18.17
1011380-S0	13.8	108	160	18.17
1021389-S0	13.891 (35/64")	108	160	19.82
1011400-S0	14	108	160	18.23
1011425-S0	14.25	114	169	18.23
1021429-S0	14.287 (9/16")	114	169	22.25
1011450-S0	14.5	114	169	20.98
1021468-S0	14.684 (37/64")	114	169	22.25
1011475-S0	14.75	114	169	20.98
1011500-S0	15	114	169	24.86
1011525-S0	15.25	120	178	24.86
1011575-S0	15.75	120	178	25.41
1021588-S0	15.875 (5/8")	120	178	26.77
1011600-S0	16	120	178	27.68
1011650-S0	16.5	125	184	30.06
1011700-S0	17	125	184	32.62
1011750-S0	17.5	130	191	35.07
1011800-S0	18	130	191	37.40
1011850-S0	18.5	135	198	39.34
1011900-S0	19	135	198	40.82
1011950-S0	19.5	140	205	42.74
1012000-S0	20	140	205	42.74

JOBBER DRILL SET IN METAL CASE

EDP NO.	Size Range	No. of drills
1060040-S0	1-13 x 0.5	25



RECOMMENDATION CUTTING CONDITIONS

Please refer to SOMTA catalogue



X-RATIO STRAIGHT SHANK JOBBER DRILLS

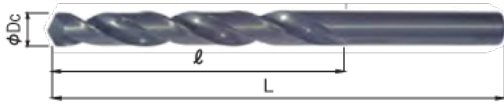

DIN 338

Unit:mm

EDP NO.	D	ℓ	L	List Price (USD)
1X50300-S0	3	33	61	0.79
1X50310-S0	3.1	36	65	0.79
1X50318-S0	3.175 (1/8)	36	65	0.79
1X50320-S0	3.2	36	65	0.79
1X50330-S0	3.3	36	65	0.79
1X50340-S0	3.4	39	70	0.79
1X50350-S0	3.5	39	70	1.03
1X50357-S0	3.572 (9/64)	39	70	1.03
1X50360-S0	3.6	39	70	1.03
1X50370-S0	3.7	39	70	1.03
1X50380-S0	3.8	43	75	1.03
1X50390-S0	3.9	43	75	1.03
1X50397-S0	3.969 (5/32)	43	75	1.03
1X50400-S0	4	43	75	2.54
1X50410-S0	4.1	43	75	2.54
1X50420-S0	4.2	43	75	2.54
1X50430-S0	4.3	47	80	2.54
1X50437-S0	4.366 (11/64)	47	80	2.54
1X50440-S0	4.4	47	80	2.54
1X50450-S0	4.5	47	80	2.57
1X50460-S0	4.6	47	80	2.57
1X50470-S0	4.7	47	80	2.57
1X50476-S0	4.762 (3/16)	52	86	2.57
1X50480-S0	4.8	52	86	2.57
1X50490-S0	4.9	52	86	2.57
1X50500-S0	5	52	86	2.59
1X50510-S0	5.1	52	86	2.59
1X50516-S0	5.159 (13/64)	52	86	2.59
1X50520-S0	5.2	52	86	2.59
1X50530-S0	5.3	52	86	2.59
1X50540-S0	5.4	57	93	2.59
1X50550-S0	5.5	57	93	2.66
1X50556-S0	5.556 (7/32)	57	93	2.66
1X50560-S0	5.6	57	93	2.66
1X50570-S0	5.7	57	93	2.66
1X50580-S0	5.8	57	93	2.66
1X50590-S0	5.9	57	93	2.66
1X50595-S0	5.953 (15/64)	57	93	2.66
1X50600-S0	6	57	93	2.84
1X50610-S0	6.1	63	101	2.84
1X50620-S0	6.2	63	101	2.84
1X50630-S0	6.3	63	101	2.84
1X50635-S0	6.350 (1/4)	63	101	2.84
1X50640-S0	6.4	63	101	2.84
1X50650-S0	6.5	63	101	3.07
1X50660-S0	6.6	63	101	3.07
1X50670-S0	6.7	63	101	3.07
1X50675-S0	6.747 (17/64)	69	109	3.07
1X50680-S0	6.8	69	109	3.07
1X50690-S0	6.9	69	109	3.07
1X50700-S0	7	69	109	4.17
1X50710-S0	7.1	69	109	4.17
1X50714-S0	7.144 (9/32)	69	109	4.17
1X50720-S0	7.2	69	109	4.17
1X50730-S0	7.3	69	109	4.17
1X50740-S0	7.4	69	109	4.17
1X50750-S0	7.5	69	109	4.19
1X50754-S0	7.541 (19/64)	75	117	4.19
1X50760-S0	7.6	75	117	4.19
1X50770-S0	7.7	75	117	4.19
1X50780-S0	7.8	75	117	4.19
1X50790-S0	7.9	75	117	4.19

EDP NO.	D	ℓ	L	List Price (USD)
1X50794-S0	7.937 (5/16)	75	117	4.19
1X50800-S0	8	75	117	4.54
1X50810-S0	8.1	75	117	4.54
1X50820-S0	8.2	75	117	4.54
1X50830-S0	8.3	75	117	4.54
1X50833-S0	8.334 (21/64)	75	117	4.54
1X50840-S0	8.4	75	117	4.54
1X50850-S0	8.5	75	117	5.16
1X50860-S0	8.6	81	125	5.16
1X50870-S0	8.7	81	125	5.16
1X50873-S0	8.731 (11/32)	81	125	5.16
1X50880-S0	8.8	81	125	5.16
1X50890-S0	8.9	81	125	5.16
1X50900-S0	9	81	125	6.07
1X50910-S0	9.1	81	125	6.07
1X50913-S0	9.128 (23/64)	81	125	6.07
1X50920-S0	9.2	81	125	6.07
1X50930-S0	9.3	81	125	6.07
1X50940-S0	9.4	81	125	6.07
1X50950-S0	9.5	81	125	6.47
1X50953-S0	9.525 (3/8)	87	133	6.47
1X50960-S0	9.6	87	133	6.47
1X50970-S0	9.7	87	133	6.47
1X50980-S0	9.8	87	133	6.47
1X50990-S0	9.9	87	133	6.47
1X50992-S0	9.922 (25/64)	87	133	6.47
1X51000-S0	10	87	133	7.04
1X51010-S0	10.1	87	133	7.04
1X51020-S0	10.2	87	133	7.04
1X51030-S0	10.3	87	133	7.04
1X51032-S0	10.319 (13/32)	87	133	7.04
1X51040-S0	10.4	87	133	7.04
1X51050-S0	10.5	87	133	7.82
1X51060-S0	10.6	87	133	7.82
1X51070-S0	10.7	94	142	7.82
1X51072-S0	10.716 (27/64)	94	142	7.82
1X51080-S0	10.8	94	142	7.82
1X51090-S0	10.9	94	142	7.82
1X51100-S0	11	94	142	8.95
1X51110-S0	11.1	94	142	8.95
1X51111-S0	11.112 (7/16)	94	142	8.95
1X51120-S0	11.2	94	142	8.95
1X51130-S0	11.3	94	142	8.95
1X51140-S0	11.4	94	142	8.95
1X51150-S0	11.5	94	142	9.58
1X51151-S0	11.509 (29/64)	94	142	9.58
1X51160-S0	11.6	94	142	9.58
1X51170-S0	11.7	94	142	9.58
1X51180-S0	11.8	94	142	9.58
1X51190-S0	11.9	101	151	9.58
1X51191-S0	11.906 (15/32)	101	151	9.58
1X51200-S0	12	101	151	10.67
1X51210-S0	12.1	101	151	10.67
1X51230-S0	12.3	101	151	10.67
1X51229-S0	12.303 (31/64)	101	151	10.67
1X51240-S0	12.4	101	151	10.67
1X51250-S0	12.5	101	151	10.88
1X51260-S0	12.6	101	151	10.88
1X51269-S0	12.700 (1/2)	101	151	10.88
1X51270-S0	12.7	101	151	10.88
1X51280-S0	12.8	101	151	10.88
1X51290-S0	12.9	101	151	10.88
1X51300-S0	13	101	151	11.57

RECOMMENDATION CUTTING CONDITIONS

Please refer to SOMTA catalogue



FOR GENERAL/ HIGH TENSILE STEELS

NDX JOBBER DRILLS - HEAVY DUTY

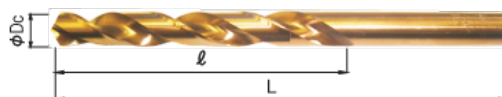

Unit:mm

EDP NO.	Dc	ℓ	L	List Price (USD)
1770100-S0	1	12	34	1.12
1770150-S0	1.5	18	40	1.08
1770159-S0	1.587 (1/16")	20	43	1.02
1770160-S0	1.6	20	43	1.08
1770170-S0	1.7	20	43	1.08
1770180-S0	1.8	22	46	1.08
1770190-S0	1.9	22	46	1.08
1770198-S0	1.984 (5/64")	24	49	1.02
1770200-S0	2	24	49	1.25
1770210-S0	2.1	24	49	1.25
1770220-S0	2.2	27	53	1.25
1770230-S0	2.3	27	53	1.25
1770238-S0	2.381 (3/32")	30	57	1.02
1770240-S0	2.4	30	57	1.25
1770250-S0	2.5	30	57	1.25
1770260-S0	2.6	30	57	1.25
1770270-S0	2.7	33	61	1.25
1770278-S0	2.778 (7/64")	33	61	1.18
1770280-S0	2.8	33	61	1.25
1770290-S0	2.9	33	61	1.25
1770300-S0	3	33	61	1.46
1770318-S0	3.175 (1/8")	36	65	2.16
1770320-S0	3.2	36	65	1.46
1770330-S0	3.3	36	65	1.46
1770340-S0	3.4	39	70	1.46
1770350-S0	3.5	39	70	1.36
1770357-S0	3.572 (9/64")	39	70	2.16
1770360-S0	3.6	39	70	1.36
1770370-S0	3.7	39	70	1.36
1770380-S0	3.8	43	75	1.36
1770390-S0	3.9	43	75	1.36
1770397-S0	3.969 (5/32")	43	75	2.16
1770400-S0	4	43	75	1.37
1770410-S0	4.1	43	75	1.37
1770420-S0	4.2	43	75	1.37
1770430-S0	4.3	47	80	1.37
1770437-S0	4.366 (11/64")	47	80	2.90
1770440-S0	4.4	47	80	1.37
1770450-S0	4.5	47	80	2.77
1770460-S0	4.6	47	80	2.77
1770470-S0	4.7	47	80	2.77
1770476-S0	4.762 (3/16")	52	86	2.85
1770480-S0	4.8	52	86	2.77
1770490-S0	4.9	52	86	2.77
1770500-S0	5	52	86	3.07
1770510-S0	5.1	52	86	3.07
1770516-S0	5.159 (13/64")	52	86	3.42
1770520-S0	5.2	52	86	3.07
1770530-S0	5.3	52	86	3.07
1770540-S0	5.4	57	93	3.07
1770550-S0	5.5	57	93	3.56
1770556-S0	5.556 (7/32")	57	93	3.71
1770560-S0	5.6	57	93	3.56
1770570-S0	5.7	57	93	3.56
1770580-S0	5.8	57	93	3.56
1770590-S0	5.9	57	93	3.56
1770595-S0	5.953 (15/64")	57	93	4.06
1770600-S0	6	57	93	4.06
1770610-S0	6.1	63	101	4.06
1770620-S0	6.2	63	101	4.06
1770630-S0	6.3	63	101	4.06
1770635-S0	6.350 (1/4")	63	101	4.50
1770640-S0	6.4	63	101	4.06
1770650-S0	6.5	63	101	4.50
1770660-S0	6.6	63	101	4.50
1770670-S0	6.7	63	101	4.50
1770675-S0	6.747 (17/64")	69	109	4.50
1770680-S0	6.8	69	109	4.50

Unit:mm

DIN 338

EDP NO.	Dc	ℓ	L	List Price (USD)
1770690-S0	6.9	69	109	4.50
1770700-S0	7	69	109	5.26
1770710-S0	7.1	69	109	5.26
1770720-S0	7.2	69	109	5.26
1770730-S0	7.3	69	109	5.26
1770740-S0	7.4	69	109	5.26
1770750-S0	7.5	69	109	5.97
1770754-S0	7.541 (19/64")	75	117	6.46
1770760-S0	7.6	75	117	5.97
1770770-S0	7.7	75	117	5.97
1770780-S0	7.8	75	117	5.97
1770790-S0	7.9	75	117	5.97
1770794-S0	7.937 (5/16")	75	117	6.61
1770800-S0	8	75	117	6.78
1770810-S0	8.1	75	117	6.78
1770820-S0	8.2	75	117	6.78
1770830-S0	8.3	75	117	6.78
1770833-S0	8.334 (21/64")	75	117	7.44
1770840-S0	8.4	75	117	6.78
1770850-S0	8.5	75	117	7.44
1770860-S0	8.6	81	125	7.44
1770870-S0	8.7	81	125	7.44
1770873-S0	8.731 (11/32")	81	125	8.65
1770880-S0	8.8	81	125	7.44
1770890-S0	8.9	81	125	7.44
1770900-S0	9	81	125	8.35
1770910-S0	9.1	81	125	8.35
1770920-S0	9.2	81	125	8.35
1770930-S0	9.3	81	125	8.35
1770940-S0	9.4	81	125	8.35
1770950-S0	9.5	81	125	9.19
1770953-S0	9.525 (3/8")	87	133	9.03
1770960-S0	9.6	87	133	9.19
1770970-S0	9.7	87	133	9.19
1770980-S0	9.8	87	133	9.19
1770990-S0	9.9	87	133	9.19
1771000-S0	10	87	133	10.30
1771010-S0	10.1	87	133	10.30
1771020-S0	10.2	87	133	10.30
1771030-S0	10.3	87	133	10.30
1771032-S0	10.319 (13/32")	87	133	11.45
1771040-S0	10.4	87	133	10.30
1771050-S0	10.5	87	133	11.40
1771070-S0	10.7	94	142	11.40
1771080-S0	10.8	94	142	11.40
1771090-S0	10.9	94	142	11.40
1771100-S0	11	94	142	12.62
1771110-S0	11.1	94	142	12.62
1771111-S0	11.112 (7/16")	94	142	13.92
1771120-S0	11.2	94	142	12.62
1771130-S0	11.3	94	142	12.62
1771140-S0	11.4	94	142	12.62
1771150-S0	11.5	94	142	13.93
1771170-S0	11.7	94	142	13.93
1771180-S0	11.8	94	142	13.93
1771190-S0	11.9	101	151	13.93
1771200-S0	12	101	151	15.04
1771210-S0	12.1	101	151	15.04
1771220-S0	12.2	101	151	15.04
1771230-S0	12.3	101	151	15.04
1771240-S0	12.4	101	151	15.04
1771250-S0	12.5	101	151	16.72
1771260-S0	12.6	101	151	16.72
1771269-S0	12.700 (1/2")	101	151	16.84
1771270-S0	12.7	101	151	16.72
1771280-S0	12.8	101	151	16.72
1771290-S0	12.9	101	151	16.72
1771300-S0	13	101	151	17.37

RECOMMENDATION CUTTING CONDITIONS

Please refer to SOMTA catalogue

GENERAL PURPOSE



REDUCED SHANK (ELECTRICIANS) DRILLS

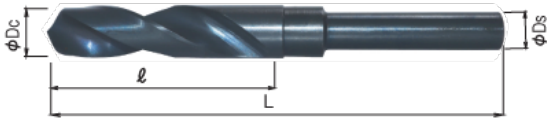

Unit:mm

Unit:mm

EDP NO.	Dc	l	L	Ds	List Price (USD)
1751100-S0	11	94	142	10	6.29
1751150-S0	11.5	94	142	10	6.14
1751200-S0	12	101	151	10	13.75
1751250-S0	12.5	101	151	10	13.75
1761270-S0	12.700 (1/2")	101	151	10	14.68
1751300-S0	13	80	152	10	13.75
1761349-S0	13.494 (17/32")	80	152	1/2"	15.37
1751350-S0	13.5	80	152	12.7	13.75
1751400-S0	14	80	152	12.7	15.77
1761429-S0	14.287 (9/16")	80	152	1/2"	15.77
1751450-S0	14.5	80	152	12.7	16.45
1751500-S0	15	80	152	12.7	17.21
1761508-S0	15.081 (19/32")	80	152	1/2"	17.21
1751550-S0	15.5	80	152	12.7	17.94
1761588-S0	15.875 (5/8")	80	152	1/2"	18.70
1751600-S0	16	80	152	12.7	19.46
1751650-S0	16.5	80	152	12.7	20.27
1761667-S0	16.669 (21/32")	80	152	1/2"	20.27
1751700-S0	17	80	152	12.7	21.08
1761746-S0	17.462 (11/16")	80	152	1/2"	21.88
1751750-S0	17.5	80	152	12.7	21.88

EDP NO.	Dc	l	L	Ds	List Price (USD)
1751800-S0	18	80	152	12.7	23.58
1751850-S0	18.5	80	152	12.7	24.43
1751900-S0	19	80	152	12.7	25.31
1761905-S0	19.050 (3/4")	80	152	1/2"	25.31
1751950-S0	19.5	76	152	12.7	26.20
1752000-S0	20	76	152	12.7	28.04
1752050-S0	20.5	76	152	12.7	29.00
1762064-S0	20.637 (13/16")	76	152	1/2"	29.00
1752100-S0	21	76	152	12.7	30.44
1752150-S0	21.5	76	152	12.7	30.92
1752200-S0	22	76	152	12.7	32.92
1762223-S0	22.225 (7/8")	76	152	1/2"	32.92
1752250-S0	22.5	76	152	12.7	33.96
1752300-S0	23	76	152	12.7	35.64
1752350-S0	23.5	76	152	12.7	36.04
1762381-S0	23.812 (15/16")	76	152	1/2"	37.12
1752400-S0	24	76	152	12.7	38.18
1752450-S0	24.5	76	152	12.7	39.29
1752500-S0	25	76	152	12.7	40.40
1762540-S0	25.400 (1")	76	152	1/2"	41.54

RECOMMENDATION CUTTING CONDITIONS

Please refer to SOMTA catalogue



GENERAL PURPOSE

STRAIGHT SHANK LONG SERIES DRILLS

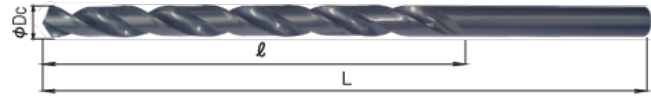

Unit:mm

EDP NO.	Dc	l	L	List Price (USD)
1160100-S0	1	33	56	3.00
1160110-S0	1.1	37	60	2.93
1160120-S0	1.2	41	65	2.93
1160130-S0	1.3	41	65	2.93
1160140-S0	1.4	45	70	2.93
1160150-S0	1.5	45	70	2.93
1170159-S0	1.587 (1/16")	50	76	3.22
1160160-S0	1.6	50	76	3.16
1160170-S0	1.7	50	76	3.16
1160180-S0	1.8	53	80	3.20
1160190-S0	1.9	53	80	3.20
1160200-S0	2	56	85	3.20
1160210-S0	2.1	56	85	3.20
1160220-S0	2.2	59	90	3.20
1160230-S0	2.3	59	90	3.20
1170238-S0	2.381 (3/32")	62	95	3.28
1160240-S0	2.4	62	95	3.20
1160250-S0	2.5	62	95	3.20
1160260-S0	2.6	62	95	3.38
1160270-S0	2.7	66	100	3.38
1160280-S0	2.8	66	100	3.38
1160290-S0	2.9	66	100	3.37
1160300-S0	3	66	100	3.37
1160310-S0	3.1	69	106	4.11
1170318-S0	3.175 (1/8")	69	106	4.11
1160320-S0	3.2	69	106	4.11
1160330-S0	3.3	69	106	4.06
1160340-S0	3.4	73	112	4.11
1160350-S0	3.5	73	112	4.06
1160360-S0	3.6	73	112	2.12
1160370-S0	3.7	73	112	2.12
1160380-S0	3.8	78	119	2.12
1160390-S0	3.9	78	119	2.12
1170397-S0	3.969 (5/32")	78	119	2.12
1160400-S0	4	78	119	2.12
1160410-S0	4.1	78	119	2.63
1160420-S0	4.2	78	119	2.63
1160430-S0	4.3	82	126	2.75
1160440-S0	4.4	82	126	2.75
1160450-S0	4.5	82	126	2.68
1160460-S0	4.6	82	126	3.91
1160470-S0	4.7	82	126	3.18
1170476-S0	4.762 (3/16")	87	132	3.18
1160480-S0	4.8	87	132	3.10
1160490-S0	4.9	87	132	3.18
1160500-S0	5	87	132	3.10
1160510-S0	5.1	87	132	4.28
1160520-S0	5.2	87	132	4.18
1160530-S0	5.3	87	132	4.28
1160540-S0	5.4	91	139	4.28
1160550-S0	5.5	91	139	4.28
1170556-S0	5.556 (7/32")	91	139	4.67
1160560-S0	5.6	91	139	4.68
1160570-S0	5.7	91	139	4.80
1160580-S0	5.8	91	139	4.68

Unit:mm

DIN 340

EDP NO.	Dc	l	L	List Price (USD)
1160590-S0	5.9	91	139	4.80
1160600-S0	6	91	139	4.68
1160610-S0	6.1	97	148	5.31
1160620-S0	6.2	97	148	5.31
1160630-S0	6.3	97	148	5.31
1170635-S0	6.350 (1/4")	97	148	5.31
1160640-S0	6.4	97	148	5.31
1160650-S0	6.5	97	148	5.31
1160660-S0	6.6	97	148	6.33
1160670-S0	6.7	97	148	6.33
1160680-S0	6.8	102	156	6.22
1160690-S0	6.9	102	156	6.88
1160700-S0	7	102	156	6.33
1160710-S0	7.1	102	156	7.44
1170714-S0	7.144 (9/32")	102	156	7.24
1160720-S0	7.2	102	156	7.27
1160730-S0	7.3	102	156	7.44
1160740-S0	7.4	102	156	7.44
1160750-S0	7.5	102	156	7.27
1160760-S0	7.6	109	165	9.50
1160770-S0	7.7	109	165	10.67
1160780-S0	7.8	109	165	9.50
1160790-S0	7.9	109	165	9.50
1170794-S0	7.937 (5/16")	109	165	9.26
1160800-S0	8	109	165	9.29
1160820-S0	8.2	109	165	10.74
1160850-S0	8.5	109	165	10.18
1170873-S0	8.731 (11/32")	115	175	11.98
1160880-S0	8.8	115	175	12.27
1160900-S0	9	115	175	12.27
1160920-S0	9.2	115	175	13.44
1160950-S0	9.5	115	175	13.13
1170953-S0	9.525 (3/8")	121	184	15.80
1160980-S0	9.8	121	184	15.80
1161000-S0	10	121	184	15.72
1161020-S0	10.2	121	184	16.73
1171032-S0	10.319 (13/32")	121	184	16.68
1161050-S0	10.5	121	184	17.00
1161080-S0	10.8	128	195	19.70
1161100-S0	11	128	195	19.70
1171111-S0	11.112 (7/16")	128	195	21.50
1161120-S0	11.2	128	195	21.50
1161150-S0	11.5	128	195	21.50
1161180-S0	11.8	128	195	24.60
1161200-S0	12	134	205	24.31
1161220-S0	12.2	134	205	28.03
1161250-S0	12.5	134	205	26.85
1171270-S0	12.7 (1/2")	134	205	28.90
1161280-S0	12.8	134	205	28.90
1161300-S0	13	134	205	28.42
1161400-S0	14	140	214	20.74
1171429-S0	14.287 (9/16")	144	220	23.98
1161500-S0	15	144	220	41.49
1171588-S0	15.875 (5/8")	149	227	44.13
1161600-S0	16	149	227	44.13

GENERAL PURPOSE



STRAIGHT SHANK EXTRA LENGTH DRILLS

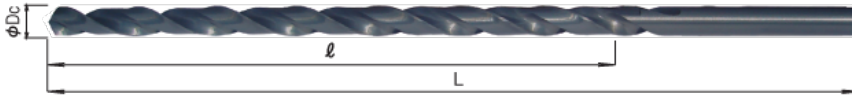

ISO-3292

Unit:mm

EDP NO.	Dc	ℓ	L	List Price (USD)
1220150-S0	1.5	100	160	6.76
1210200-S0	2	80	125	5.74
1220200-S0	2	100	160	6.76
1230200-S0	2	160	200	9.87
1210250-S0	2.5	80	125	5.74
1220250-S0	2.5	100	160	6.76
1230250-S0	2.5	160	200	9.87
1210300-S0	3	80	125	8.31
1220300-S0	3	100	160	9.36
1230300-S0	3	160	200	13.28
1240300-S0	3	200	250	19.76
1250300-S0	3	250	315	25.63
1220350-S0	3.5	100	160	9.36
1230350-S0	3.5	160	200	12.43
1240350-S0	3.5	200	250	18.86
1220400-S0	4	100	160	9.36
1230400-S0	4	160	200	13.28
1240400-S0	4	200	250	19.76
1250400-S0	4	250	315	24.82
1260400-S0	4	300	400	37.55
1220450-S0	4.5	100	160	9.36
1230450-S0	4.5	160	200	12.43
1240450-S0	4.5	200	250	23.51
1220500-S0	5	100	160	9.36
1230500-S0	5	160	200	13.28
1240500-S0	5	200	250	22.80
1250500-S0	5	250	315	31.70
1260500-S0	5	300	400	37.55
1220550-S0	5.5	100	160	9.36
1230550-S0	5.5	160	200	13.28
1240550-S0	5.5	200	250	21.94
1220600-S0	6	100	160	12.08
1230600-S0	6	160	200	17.38
1240600-S0	6	200	250	24.83
1250600-S0	6	250	315	31.70
1260600-S0	6	300	400	49.87

Unit:mm

EDP NO.	Dc	ℓ	L	List Price (USD)
1230650-S0	6.5	160	200	17.38
1240650-S0	6.5	200	250	23.99
1230700-S0	7	160	200	19.54
1240700-S0	7	200	250	27.92
1250700-S0	7	250	315	35.63
1260700-S0	7	300	400	47.71
1230750-S0	7.5	160	200	18.80
1240750-S0	7.5	200	250	27.11
1230800-S0	8	160	200	19.54
1240800-S0	8	200	250	27.92
1250800-S0	8	250	315	35.63
1260800-S0	8	300	400	47.71
1230850-S0	8.5	160	200	22.86
1240850-S0	8.5	200	250	34.08
1230900-S0	9	160	200	22.86
1240900-S0	9	200	250	33.37
1250900-S0	9	250	315	44.18
1260900-S0	9	300	400	56.19
1230950-S0	9.5	160	200	22.16
1240950-S0	9.5	200	250	33.37
1231000-S0	10	160	200	22.86
1241000-S0	10	200	250	34.08
1251000-S0	10	250	315	44.72
1261000-S0	10	300	400	56.19
1241050-S0	10.5	200	250	37.71
1241100-S0	11	200	250	37.71
1251100-S0	11	250	315	50.10
1261100-S0	11	300	400	70.95
1241150-S0	11.5	200	250	37.27
1241200-S0	12	200	250	37.71
1251200-S0	12	250	315	50.10
1261200-S0	12	300	400	70.95
1241250-S0	12.5	200	250	41.68
1241300-S0	13	200	250	45.97
1251300-S0	13	250	315	59.25
1261300-S0	13	300	400	94.09

RECOMMENDATION CUTTING CONDITIONS

Please refer to SOMTA catalogue



MORSE TAPER SHANK DRILLS

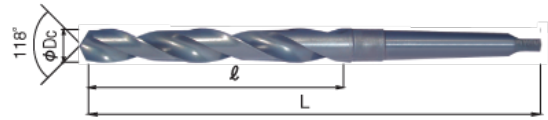

DIN 345

Unit:mm

		ℓ	L	Ds	List Price (USD)
2010300-S0	3	33	114	MT1	12.19
2010350-S0	3.5	39	120	MT1	12.34
2010400-S0	4	43	124	MT1	13.73
2010450-S0	4.5	47	128	MT1	13.73
2010500-S0	5	52	133	MT1	13.74
2010550-S0	5.5	57	138	MT1	17.84
2010600-S0	6	57	138	MT1	17.84
2010650-S0	6.5	63	144	MT1	17.84
2010700-S0	7	69	150	MT1	17.84
2010750-S0	7.5	69	150	MT1	17.84
2010800-S0	8	75	156	MT1	17.87
2010850-S0	8.5	75	156	MT1	17.90
2010900-S0	9	81	162	MT1	17.93
2010950-S0	9.5	81	162	MT1	17.98
2011000-S0	10	87	168	MT1	18.02
2011050-S0	10.5	87	168	MT1	18.05
2011100-S0	11	94	175	MT1	18.12
2011150-S0	11.5	94	175	MT1	18.16
2011200-S0	12	101	182	MT1	18.35
2011250-S0	12.5	101	182	MT1	19.58
2011300-S0	13	101	182	MT1	19.58
2011350-S0	13.5	108	189	MT1	22.15
2011400-S0	14	108	189	MT1	22.15
2021400-S0	-14	114	212	MT2	22.90
2021450-S0	14.5	114	212	MT2	22.92
2021500-S0	15	114	212	MT2	22.98
2021550-S0	15.5	120	218	MT2	25.94
2021600-S0	16	120	218	MT2	28.00
2021650-S0	16.5	125	223	MT2	30.41
2021700-S0	17	125	223	MT2	30.78
2021750-S0	17.5	130	228	MT2	32.09
2021800-S0	18	130	228	MT2	32.09
2021850-S0	18.5	135	233	MT2	36.08
2021900-S0	19	135	233	MT2	36.08
2021950-S0	19.5	140	238	MT2	40.21
2022000-S0	20	140	238	MT2	40.21
2022050-S0	20.5	145	243	MT2	41.83
2022100-S0	21	145	243	MT2	41.58
2022150-S0	21.5	150	248	MT2	46.07
2022200-S0	22	150	248	MT2	47.38
2022250-S0	22.5	155	253	MT2	47.59
2022300-S0	23	155	253	MT2	54.26
2032350-S0	23.5	155	276	MT3	54.26
2032400-S0	24	160	281	MT3	54.26
2032450-S0	24.5	160	281	MT3	57.64
2032500-S0	25	160	281	MT3	57.64
2032550-S0	25.5	165	286	MT3	62.93
2032600-S0	26	165	286	MT3	62.93
2032650-S0	26.5	165	286	MT3	65.24

Unit:mm

		ℓ	L	Ds	List Price (USD)
2032700-S0	27	170	291	MT3	65.37
2032750-S0	27.5	170	291	MT3	68.41
2032800-S0	28	170	291	MT3	68.41
2032850-S0	28.5	175	296	MT3	65.87
2032900-S0	29	175	296	MT3	78.54
2032950-S0	29.5	175	296	MT3	89.10
2033000-S0	30	175	296	MT3	89.10
2033050-S0	30.5	180	301	MT3	93.49
2033100-S0	31	180	301	MT3	104.71
2033150-S0	31.5	180	301	MT3	104.71
2033200-S0	32	185	306	MT3	121.54
2043200-S0	32	185	334	MT4	121.54
2043250-S0	32.5	185	334	MT4	123.95
2043300-S0	33	185	334	MT4	124.14
2043350-S0	33.5	185	334	MT4	138.68
2043400-S0	34	190	339	MT4	138.68
2043450-S0	34.5	190	339	MT4	143.23
2043500-S0	35	190	339	MT4	143.23
2043550-S0	35.5	190	339	MT4	145.16
2043600-S0	36	195	344	MT4	145.16
2043650-S0	36.5	195	344	MT4	145.68
2043700-S0	37	195	344	MT4	146.94
2043750-S0	37.5	195	344	MT4	165.75
2043800-S0	38	200	349	MT4	165.75
2043850-S0	38.5	200	349	MT4	167.14
2043900-S0	39	200	349	MT4	167.14
2043950-S0	39.5	200	349	MT4	167.14
2044000-S0	40	200	349	MT4	167.14
2044050-S0	40.5	205	354	MT4	171.21
2044100-S0	41	205	354	MT4	171.21
2044150-S0	41.5	205	354	MT4	171.21
2044200-S0	42	205	354	MT4	171.21
2044250-S0	42.5	205	354	MT4	183.93
2044300-S0	43	210	359	MT4	183.93
2044350-S0	43.5	210	359	MT4	236.45
2044400-S0	44	210	359	MT4	236.45
2044450-S0	44.5	210	359	MT4	236.45
2044500-S0	45	210	359	MT4	236.45
2044550-S0	45.5	215	359	MT4	241.84
2044600-S0	46	215	364	MT4	243.80
2044650-S0	46.5	215	364	MT4	273.55
2044700-S0	47	215	364	MT4	273.55
2044750-S0	47.5	215	364	MT4	273.55
2044800-S0	48	220	369	MT4	273.55
2044850-S0	48.5	220	369	MT4	273.55
2044900-S0	49	220	369	MT4	273.55
2044950-S0	49.5	220	369	MT4	300.58
2045000-S0	50	220	369	MT4	300.58

RECOMMENDATION CUTTING CONDITIONS

Please refer to SOMTA catalogue



MTS EXTRA LENGTH DRILL

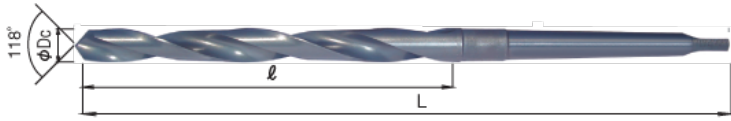

Unit:mm

EDP NO.	D _c	ℓ	L	D _s	List Price (USD)
2421000-S0	10	200	315	MT1	49.57
2421050-S0	10.5	200	315	MT1	106.35
2421100-S0	11	200	315	MT1	77.03
2441100-S0	11	300	400	MT1	129.45
2421150-S0	11.5	200	315	MT1	107.26
2421200-S0	12	200	315	MT1	77.76
2441200-S0	12	300	400	MT1	93.57
2421300-S0	13	200	315	MT1	77.78
2441300-S0	13	300	400	MT1	89.73
2421400-S0	14	200	315	MT1	73.89
2441400-S0	14	300	400	MT1	95.71
2421500-S0	15	200	315	MT2	58.68
2441500-S0	15	300	400	MT2	82.36
2421600-S0	16	200	315	MT2	59.56
2441600-S0	16	300	400	MT2	90.33
2421700-S0	17	200	315	MT2	60.16
2441700-S0	17	300	400	MT2	84.54
2421800-S0	18	200	315	MT2	57.67

Unit:mm

EDP NO.	D _c	ℓ	L	D _s	List Price (USD)
2441800-S0	18	300	400	MT2	82.05
2421900-S0	19	200	315	MT2	70.11
2441900-S0	19	300	400	MT2	92.98
2422000-S0	20	200	315	MT2	92.54
2442000-S0	20	300	400	MT2	106.79
2422100-S0	21	200	315	MT2	79.85
2442100-S0	21	300	400	MT2	132.13
2422200-S0	22	200	315	MT2	84.79
2442200-S0	22	300	400	MT2	118.03
2422300-S0	23	200	315	MT2	88.66
2442300-S0	23	300	400	MT2	123.50
2442400-S0	24	300	450	MT3	163.98
2442500-S0	25	300	450	MT3	147.70
2442600-S0	26	300	450	MT3	181.60
2442700-S0	27	300	450	MT3	187.55
2442800-S0	28	300	450	MT3	191.90
2442900-S0	29	300	450	MT3	175.46
2443000-S0	30	300	450	MT3	191.17

RECOMMENDATION CUTTING CONDITIONS

Please refer to SOMTA catalogue



GENERAL PURPOSE

NC SPOT DRILL

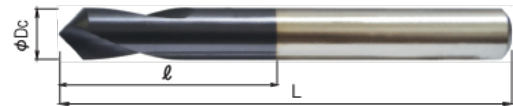

DIN 1879

Unit:mm

EDP NO.	Dc	ℓ	L	List Price (USD)
1840300-S0	3	10	46	2.33
1840400-S0	4	12	55	3.03
1840500-S0	5	14	62	3.40
1840600-S0	6	16	66	4.67
1840800-S0	8	21	79	5.92
1841000-S0	10	25	89	8.43
1841200-S0	12	30	102	13.47
1841600-S0	16	38	115	21.77
1842000-S0	20	45	131	35.43

FORM A CENTRE DRILL

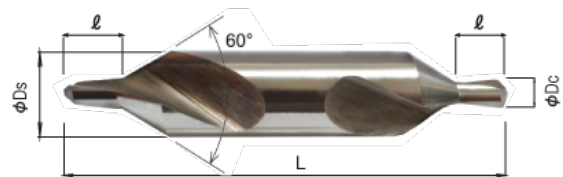

DIN 333

Unit:mm

EDP NO.	Dc	Ds	ℓ	L	List Price (USD)
1140080-S0	0.8	3.15	1.1	25	3.92
1140100-S0	1	3.15	1.3	31.5	3.65
1140125-S0	(1.25)	3.15	1.6	31.5	3.70
1140160-S0	1.6	4	2	35.5	4.01
1140200-S0	2	5	2.5	40	4.67
1140250-S0	2.5	6.3	3.1	45	4.91
1140315-S0	3.15	8	3.9	50	6.26
1140400-S0	4	10	5	56	8.39
1140500-S0	(5)	12.5	6.3	63	10.43
1140630-S0	6.3	16	8	71	14.85
1140800-S0	(8)	20	10.1	80	29.29
1141000-S0	10	25	12.8	100	39.22

GENERAL PURPOSE



PARALLEL HAND REAMERS

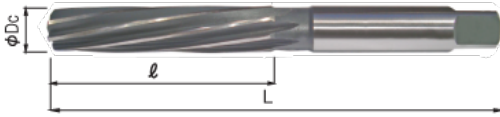

BS328
ISO 236/1
DIN206

Unit:mm

EDP NO.	Dc	ℓ	L	List Price (USD)
7010150-S0	1.5	20	41	6.56
7010200-S0	2	25	50	6.81
7010250-S0	2.5	29	58	6.89
7010300-S0	3	31	62	7.53
7010350-S0	3.5	35	71	7.16
7010400-S0	4	38	76	7.44
7010450-S0	4.5	41	81	9.77
7010500-S0	5	44	87	11.43
7010550-S0	5.5	47	93	12.08
7010600-S0	6	47	93	12.59
7010650-S0	6.5	50	100	13.55
7010700-S0	7	54	107	16.12
7010750-S0	7.5	54	107	16.75
7010800-S0	8	58	115	17.36
7010850-S0	8.5	58	115	17.83
7010900-S0	9	62	124	18.52
7010950-S0	9.5	62	124	19.88
7011000-S0	10	66	133	19.96
7011050-S0	10.5	66	133	20.42
7011100-S0	11	71	142	28.71
7011150-S0	11.5	71	142	35.48
7011200-S0	12	76	152	22.13
7011250-S0	12.5	76	152	31.00
7011300-S0	13	76	152	23.87
7011350-S0	13.5	81	163	36.20
7011400-S0	14	81	163	28.45

EDP NO.	Dc	ℓ	L	List Price (USD)
7011450-S0	14.5	81	163	37.55
7011500-S0	15	81	163	30.07
7011550-S0	15.5	87	175	41.63
7011600-S0	16	87	175	33.77
7011700-S0	17	87	175	34.52
7011800-S0	18	93	188	36.66
7011900-S0	19	93	188	39.12
7012000-S0	20	100	201	42.07
7012100-S0	21	100	201	44.58
7012200-S0	22	107	215	50.91
7012300-S0	23	107	215	53.33
7012400-S0	24	115	231	74.90
7012500-S0	25	115	231	62.42
7012600-S0	26	115	231	88.52
7012700-S0	27	115	247	75.80
7012800-S0	28	124	247	79.07
7012900-S0	29	124	247	102.66
7013000-S0	30	124	247	87.73
7013100-S0	31	133	265	114.06
7013200-S0	32	133	265	98.64
7013300-S0	33	133	265	131.22
7013400-S0	34	133	265	115.14
7013500-S0	35	133	284	119.75
7013600-S0	36	142	284	152.41
7013700-S0	37	142	284	135.29
7013800-S0	38	142	284	162.15



GENERAL PURPOSE

HAND TAPER PIN REAMERS



Unit:mm

EDP NO.	Dc	D2	D3	D4	l	a	L	List Price (USD)
7310200-S0	2	1.9	2.86	3.15	48	2.5	68	23.58
7310250-S0	2.5	2.4	3.36	3.15	48	2.5	68	24.47
7310300-S0	3	2.9	4.06	4	58	3.15	80	23.33
7310400-S0	4	3.9	5.26	5	68	4	93	25.50
7310500-S0	5	4.9	6.36	6.3	73	5	100	26.71
7310600-S0	6	5.9	8	8	105	6.3	135	35.60
7310800-S0	8	7.9	10.8	10	145	8	180	50.62
7311000-S0	10	9.9	13.4	12.5	175	10	215	55.92
7311200-S0	12	11.8	16	14	210	11.2	255	67.81
7311300-S0	(13)	12.8	17	15	210	11.2	255	74.01
7311400-S0	(14)	13.8	18	16	210	12.5	255	77.96
7311600-S0	16	15.8	20.4	18	230	14	280	96.98
7312000-S0	20	19.8	24.8	22.4	250	18	310	126.48
7312500-S0	25	24.7	30.7	28	300	22.4	370	182.62



PARALLEL SHANK MACHINE CHUCKING REAMERS



DIN 212

Unit:mm

Unit:mm

		ℓ	L	Ds	List Price (USD)
7510200-S0	2	11	49	2	9.59
7510240-S0	2.4	14	57	2.4	15.12
7510250-S0	2.5	14	57	2.5	11.26
7510260-S0	2.6	14	57	2.6	14.45
7510270-S0	2.7	15	61	2.7	14.45
7510280-S0	2.8	15	61	2.8	14.45
7510300-S0	3	15	61	3	10.56
7510310-S0	3.1	16	65	3.1	14.50
7520318-S0	3.175 (1/8)	16	65	3.2	14.50
7510320-S0	3.2	16	65	3.2	10.64
7510340-S0	3.4	18	70	3.4	14.58
7510350-S0	3.5	18	70	3.5	10.72
7510360-S0	3.6	18	70	3.6	17.49
7510380-S0	3.8	19	75	4	17.41
7510400-S0	4	19	75	4	13.64
7510410-S0	4.1	19	75	4	16.90
7510420-S0	4.2	19	75	4	13.39
7510430-S0	4.3	21	80	4.5	18.61
7510440-S0	4.4	21	80	4.5	18.61
7510450-S0	4.5	21	80	4.5	14.58
7520476-S0	4.762 (3/16)	23	86	5	19.29
7510480-S0	4.8	23	86	5	19.06
7510490-S0	4.9	23	86	5	19.06
7510500-S0	5	23	86	5	15.29
7510510-S0	5.1	23	86	5	18.80
7510520-S0	5.2	23	86	5	18.80
7510530-S0	5.3	23	86	5	15.29
7510540-S0	5.4	26	93	5.6	19.23
7510550-S0	5.5	26	93	5.6	15.46
7510560-S0	5.6	26	93	5.6	19.69
7510570-S0	5.7	26	93	5.6	19.69
7510580-S0	5.8	26	93	5.6	19.94
7510600-S0	6	26	93	5.6	16.18
7510610-S0	6.1	28	101	6.3	19.94
7510620-S0	6.2	28	101	6.3	19.94
7510630-S0	6.3	28	101	6.3	19.94
7520635-S0	6.35 (1/4)	28	101	6.3	16.19
7510640-S0	6.4	28	101	6.3	20.12
7510650-S0	6.5	28	101	6.3	20.37
7510660-S0	6.6	28	101	6.3	20.37
7510670-S0	6.7	28	101	6.3	16.61
7510680-S0	6.8	31	109	7.1	21.38
7510700-S0	7	31	109	7.1	17.62
7510710-S0	7.1	31	109	7.1	20.88
7510720-S0	7.2	31	109	7.1	20.88
7510730-S0	7.3	31	109	7.1	21.21
7510750-S0	7.5	31	109	7.1	17.37
7510780-S0	7.8	33	117	8	21.38
7510790-S0	7.9	33	117	8	21.38
7520794-S0	7.938 (5/16)	33	117	8	21.13
7510800-S0	8	33	117	8	17.56
7510810-S0	8.1	33	117	8	22.13
7510820-S0	8.2	33	117	8	21.88
7510830-S0	8.3	33	117	8	21.88

		ℓ	L	Ds	List Price (USD)
7510840-S0	8.4	33	117	8	21.62
7510850-S0	8.5	33	117	8	18.04
7510860-S0	8.6	36	125	9	23.24
7510880-S0	8.8	36	125	9	22.99
7510890-S0	8.9	36	125	9	22.74
7510900-S0	9	36	125	9	18.91
7510910-S0	9.1	36	125	9	26.19
7510950-S0	9.5	36	125	9	19.63
7520953-S0	9.525 (3/8)	38	133	10	26.59
7510960-S0	9.6	38	133	10	26.59
7510970-S0	9.7	38	133	10	26.34
7510980-S0	9.8	38	133	10	26.34
7510990-S0	9.9	38	133	10	26.09
7511000-S0	10	38	133	10	21.61
7511010-S0	10.1	38	133	10	26.62
7511020-S0	10.2	38	133	10	26.38
7511030-S0	10.3	38	133	10	26.38
7511050-S0	10.5	38	133	10	22.15
7511060-S0	10.6	38	133	10	29.02
7511070-S0	10.7	41	142	10	29.79
7511080-S0	10.8	41	142	10	29.79
7511090-S0	10.9	41	142	10	29.79
7511100-S0	11	41	142	10	24.81
7511110-S0	11.1	41	142	10	30.16
7521111-S0	11.112 (7/16)	41	142	10	30.16
7511150-S0	11.5	41	142	10	29.91
7511170-S0	11.7	41	142	10	29.65
7511180-S0	11.8	41	142	10	25.44
7511190-S0	11.9	44	151	10	31.22
7511200-S0	12	44	151	10	26.50
7511210-S0	12.1	44	151	10	31.60
7511220-S0	12.2	44	151	10	31.34
7511230-S0	12.3	44	151	10	31.34
7511240-S0	12.4	44	151	10	31.34
7511250-S0	12.5	44	151	10	27.12
7511260-S0	12.6	44	151	10	31.30
7511270-S0	12.7	44	151	10	31.30
7521270-S0	12.7 (1/2)	44	151	10	31.05
7511280-S0	12.8	44	151	10	30.79
7511290-S0	12.9	44	151	10	30.79
7511300-S0	13	44	151	10	26.56
7511350-S0	13.5	47	160	12.5	32.12
7511400-S0	14	47	160	12.5	27.53
7521429-S0	14.287 (9/16)	50	162	12.5	35.61
7511450-S0	14.5	50	162	12.5	35.61
7511500-S0	15	50	162	12.5	31.13
7511550-S0	15.5	52	170	12.5	37.64
7521588-S0	15.875 (5/8)	52	170	12.5	37.64
7511600-S0	16	52	170	12.5	32.75
7511700-S0	17	54	175	14	33.19
7511800-S0	18	56	182	14	37.91
7521905-S0	19.05 (3/4)	60	195	16	43.23
7512000-S0	20	60	195	16	45.89

RECOMMENDATION CUTTING CONDITIONS

Please refer to SOMTA catalogue





shaping your dreams

OSG GROUP Asia Pacific

SINGAPORE:

OSG ASIA PTE LTD **Singapore Asia Pacific Logistic Centre**

Address: 2 Kaki Bukit Ave 1 #03-08
Singapore 417938
Tel : (65) 6844-4350
Fax: (65) 6844-4351

MALAYSIA:

OSG ASIA PTE LTD **Malaysia Branch**

Address: S-11-07 Level 11 First Subang,
Jalan SS15/4G, Subang Jaya, 47500, Malaysia
Tel : (60) 3-5611-7415 / 7435 / 7483
Fax: (60) 3-5611-7496

VIETNAM:

OSG VIETNAM CO., LTD. **Hanoi Head Office**

Address: Room 503, 5th Floor, 15 Pham Hung Road, My Dinh 2 Ward,
Nam Tu Liem District, Hanoi City, Vietnam
Tel : (84) 24-3767-2857 / 2858
Fax: (84) 24-3767-2856

Ho Chi Minh Rep.Office

Address: 2nd Floor, 86A Xuan Thuy Street,
Thao Dien Ward, District 2, HCMC, Vietnam
Tel : (84) 283-5194-440/441
Fax: (84) 283-5194-442

Hanam Branch Office (Factory)

Address: Road N2, Section A, Hoa Mac Industrial Park, Duy Tien District
Ha Nam Province, Vietnam
Tel : (84) 226-3551-551 / 552
Fax: (84) 226-3551-553

Bac Ninh Rep. Office

Address: No.405-406, MB Building, 39 Ly Thai To Street, Suoi Hoa Ward
Bac Ninh City, Vietnam
Tel : (84) 222-360-1611 / 1612

Da Nang Rep.Office

Address: No 55 Phu Loc 1, Hoa Minh Ward, Lien Chieu District,
Da Nang City, Vietnam
Tel : (84) 236-3896-
Fax: (84) 236-3896-768

THAILAND:

OSG THAI CO., LTD **Headquarter and Factory**

Address: Wellgrow Industrial Estate 128 Moo 9 Bangwua,
Amphur Bangpakong, Chachoengsao 24180, Thailand
Tel : (66) 038-989-035

Bangna Stock Centre & Sales Office

Address: 1MD Tower 21Fl., A-B, Bangna Trad KM.3, Kawaeng Bangna,
Khet Bangna, Bangkok, 10260
Tel : (66) 2173-5870
Fax: (66) 2173-5873

Amatanakorn Sales Office

Address: Kromadit Park 700/1999 Moo 1, Tambol Bankao,
Amphur Phanthong, Chonburi
Tel : (66) 38-468-070
Fax: (66) 38-468-069

INDIA:

OSG INDIA PVT.LTD **Delhi Head Office**

Address: Plot No.6, Sector 8,
IMT Manesar, Guragon Haryana 122050
Tel : (91) 124-4009737/41

Chennai office

Address: No.316, Sidco aitema Tower,
1st Main Road, Ambattur Industrial Estate,
Chennai, Tamilnadu 600058
Tel : (91) 44-42141473/475

Pune office

Address: Plot No.197, S-block, MIDC Bhosari, Pune, Maharashtra
Tel : (91) 44-42141473/475

Bangalore office

Address: No.G10, Ground Floor, Brigade Rubix,
New no.20, HMT Factory
Main Road, Bengaluru
Karnataka 560022
Tel : (91) 80-29723031

Gujarat Office

Address: B-607, Empire Business Hub, Opp.
Shakti Farm, Science City Road, Sola
Ahmedabad-380060
Tel : (91) 079-4844-2322

PHILIPPINES:

OSG PHILIPPINES CORPORATION **Laguna Head Office**

Address: Room 203-204 GRM Building, 124 East Science Avenue,
LTP (SEZ) Binan, Laguna 4024, Philippines
Tel : (63) 49-544-0278/0279
Fax: (63) 49-544-1003

Cebu Office

Address: Room 02, Visland Building, Exit Admin Drive, Mactan Econ.
Zone 1, Brgyibo, Lapu-Lapu City, Cebu Philippines 6015
Tel : (63) 032-494-1019

INDONESIA:

PT OSG INDONESIA **Cikarang Head Office & Factory**

Address: Kawasan Industri Jababeka
Jl. Jababeka iX Kav. E 18D-18E
Wangunharja, Cikarang Utara
Kab. Bekasi 17430
INDONESIA
Tel : (62) 21-8967-7620 / 21-2928-8484
Fax: (62) 21-8967-7621

Surabaya Branch

Address: Wisma Sier Building 2nd floor, Priority Centre Room 2&3.
JL. Rungkut Industri Raya 10, Surabaya, Indonesia 60401
Tel : (62) 31-841-0978
Fax: (62) 31-847-9097

Tangerang Branch

Address: Ruko Renata 1A/3, Jalur Sutera Boulevard
Alam Sutera, Tangerang, Indonesia 15144
Tel : (62) 21-2977-9664